

# MOLLER Experimental Apparatus Overview

Kent Paschke

# Electron Scattering and Parity-Violation

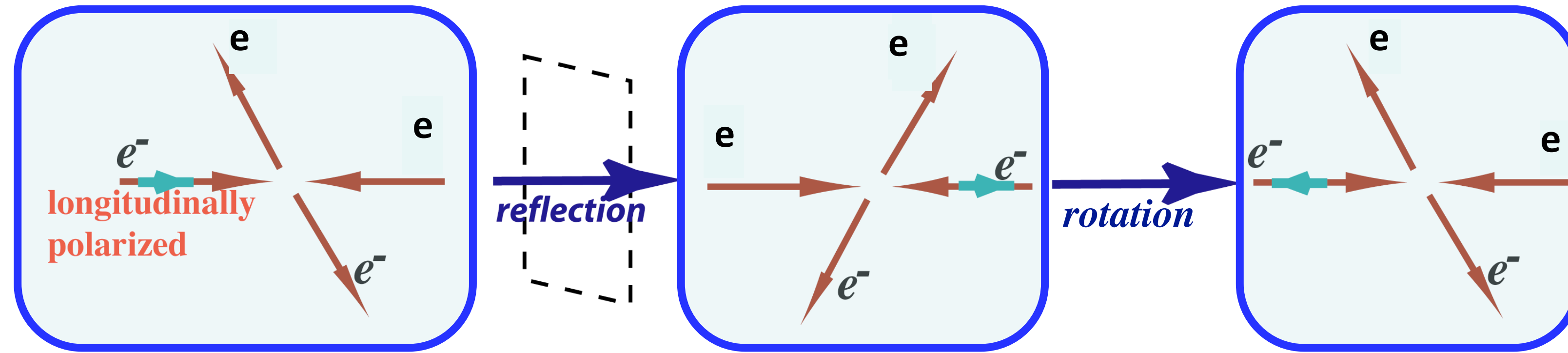

- Incident beam is longitudinally polarized
- Change sign of longitudinal polarization
- Measure fractional rate difference

$$A_{PV} = \frac{\sigma_R - \sigma_L}{\sigma_R + \sigma_L} \sim \frac{\begin{array}{c} \text{ } \\ \text{ } \end{array}}{\begin{array}{c} \text{ } \\ \text{ } \end{array}} \propto \frac{|\mathcal{M}_Z|}{|\mathcal{M}_\gamma|}$$

The diagram shows two Feynman diagrams for electron-electron scattering. The top diagram shows a photon ( $\gamma$ ) exchange between two electrons. The bottom diagram shows a  $Z^0$  boson exchange between two electrons. The ratio of the amplitudes is proportional to the ratio of the magnitudes of the matrix elements  $\mathcal{M}_Z$  and  $\mathcal{M}_\gamma$ .

Measuring ee elastic (Møller) scattering

$$A_{PV} \propto Q_W^e = 1 - 4 \sin^2 \theta_W$$

# The Weak Mixing Angle

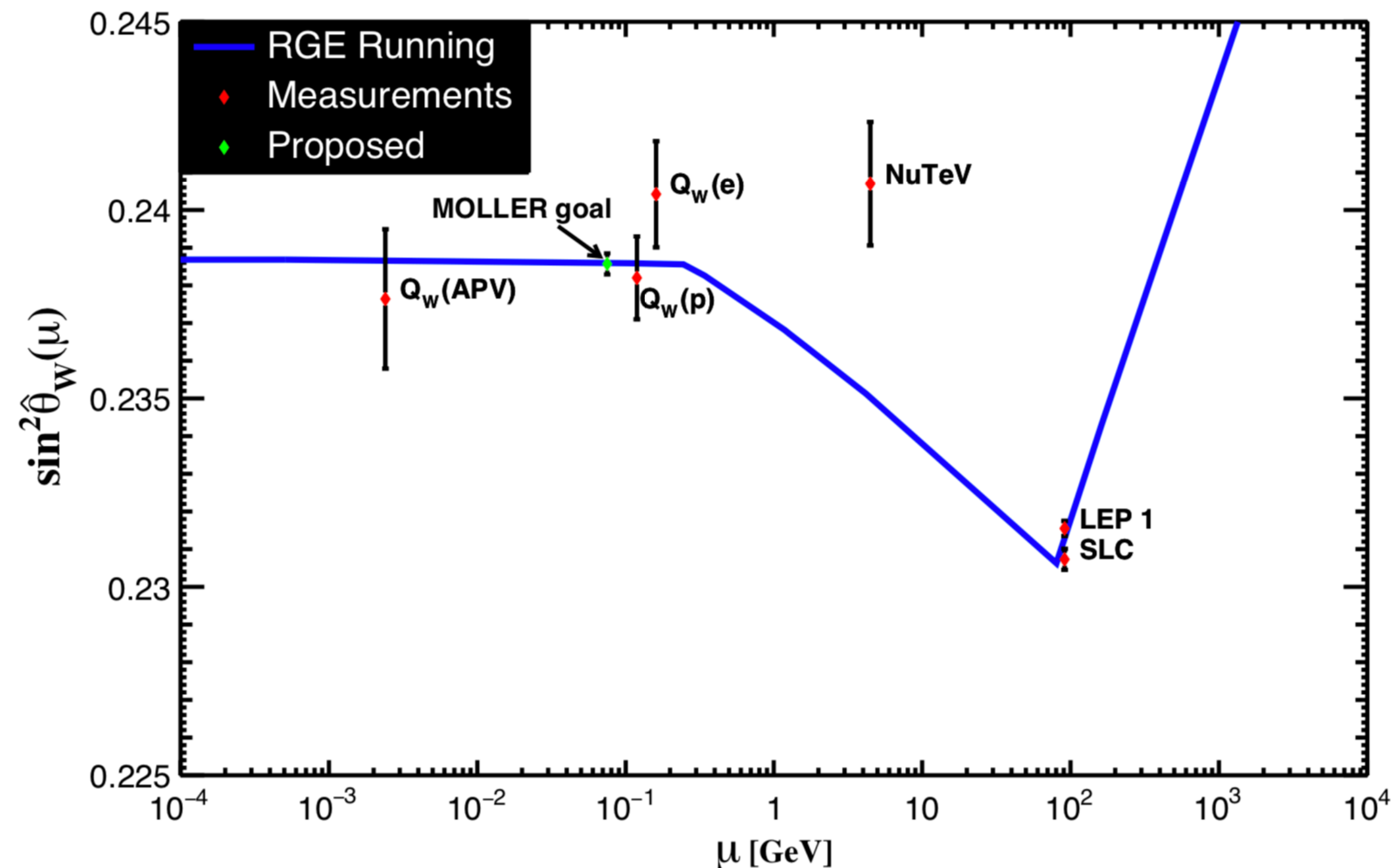
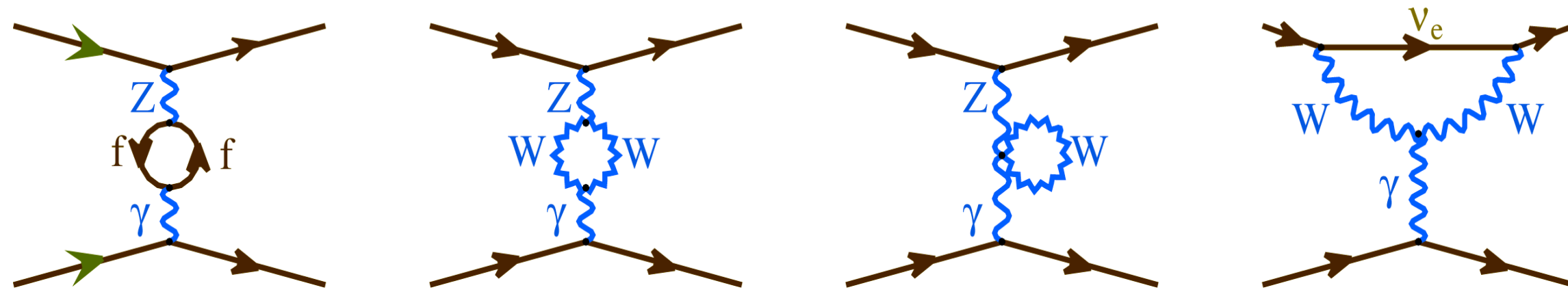

Renormalization scheme defines  $\sin^2\theta_W$  at the Z-pole.

$\gamma$ -Z mixing and other diagrams are absorbed into the coupling constant

At the Z-pole - measuring properties of the SM  $Z^0$  boson

Off the Z-pole, low-energy measurements are sensitive to (new) parity-violating interactions

$\delta(\sin^2\theta_W) = \pm 0.00024$  (stat.)  $\pm 0.00013$  (syst.)  $\Rightarrow \sim 0.1\%$   
**Matches best collider (Z-pole) measurement!**

# MOLLER

parity-violation in  $e^-e^-$  elastic scattering

$$A_{PV} = 35.6 \text{ ppb}$$

$$\delta(A_{PV}) = 0.73 \text{ parts per billion}$$

$$\delta(Q^e_W) = \pm 2.1 \% \text{ (stat)} \pm 1.0 \% \text{ (syst)}$$

signal rate: 135 GHz

run time: 8200 hours

$\sim 3 \times 10^{18}$  electrons detected

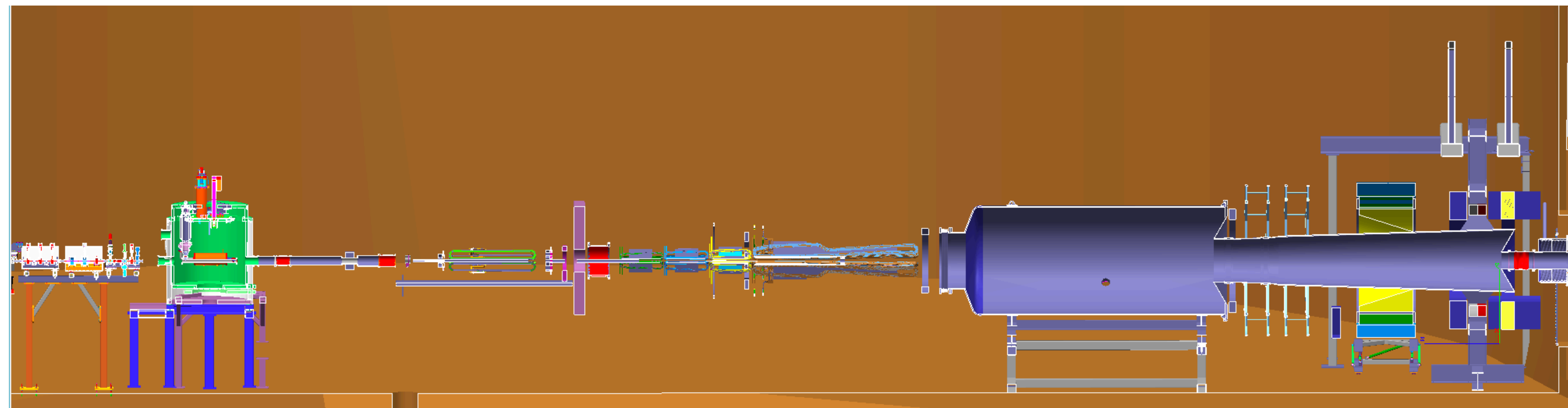

# Measuring this small asymmetry

Rapid (2kHz) helicity reversals

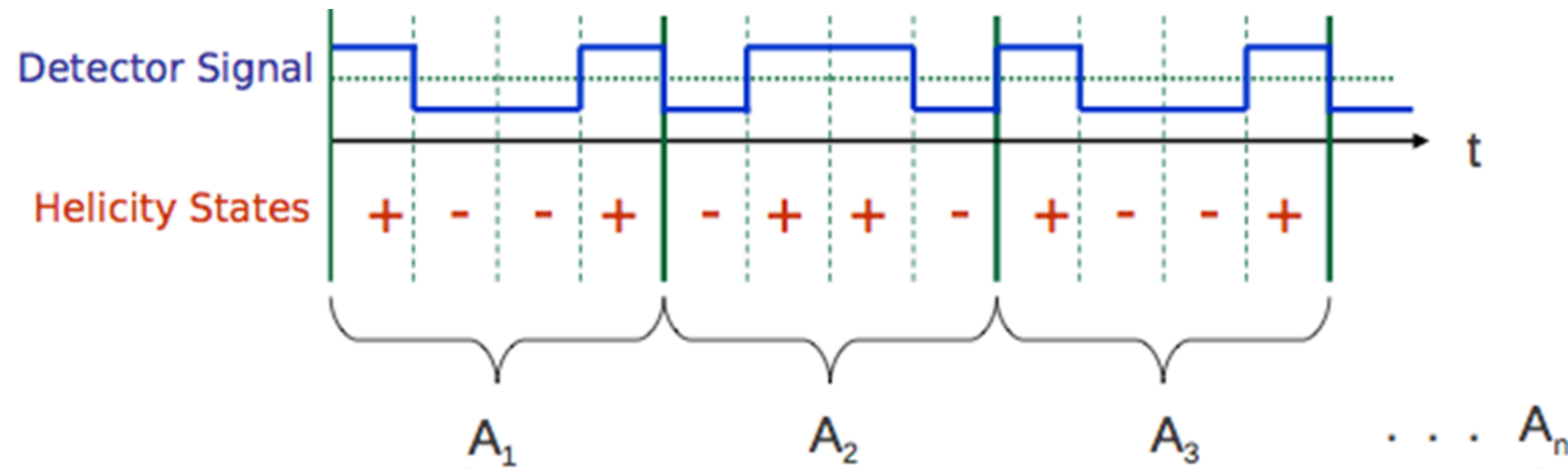

Place a detector where it sees the Møller scattered electron

Analog integrate detector current

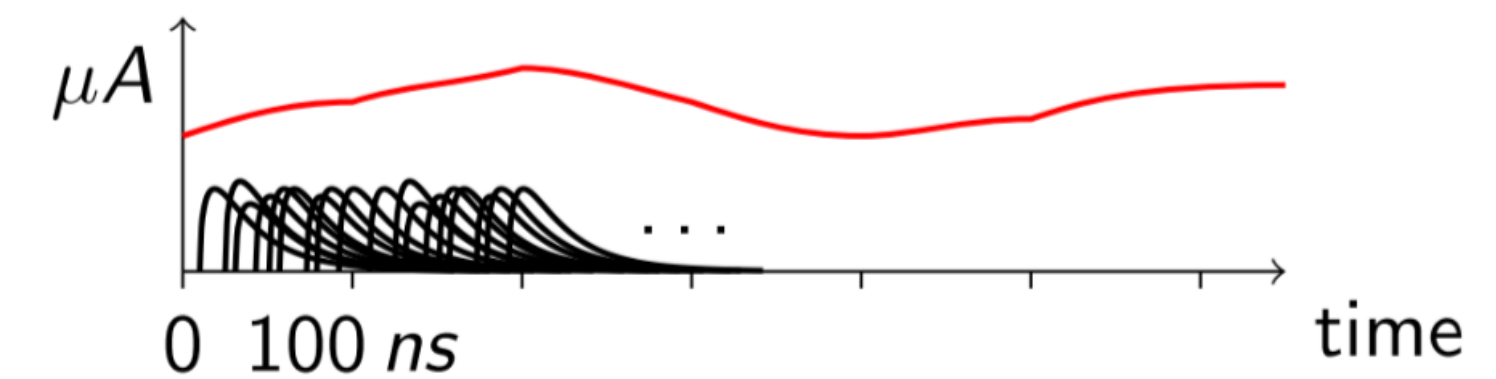

Form an asymmetry over the helicity reversal

Measure to 0.01% at 1 kHz,  
repeat for a year straight

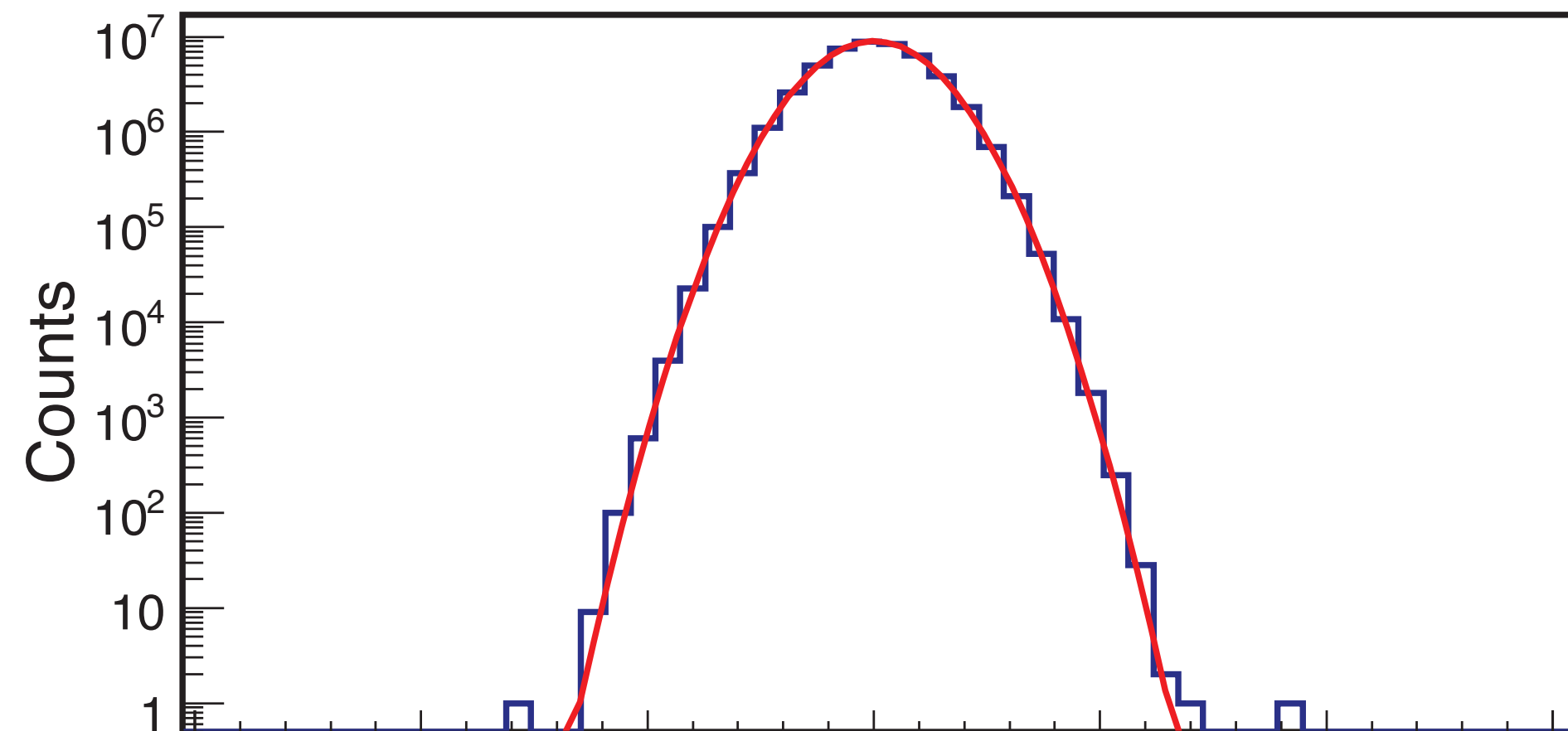

Specialized experimental techniques

- Precise spectrometer to separate signal
- Low noise electronics
- Precise beam control and measurement
- ...

# High Precision

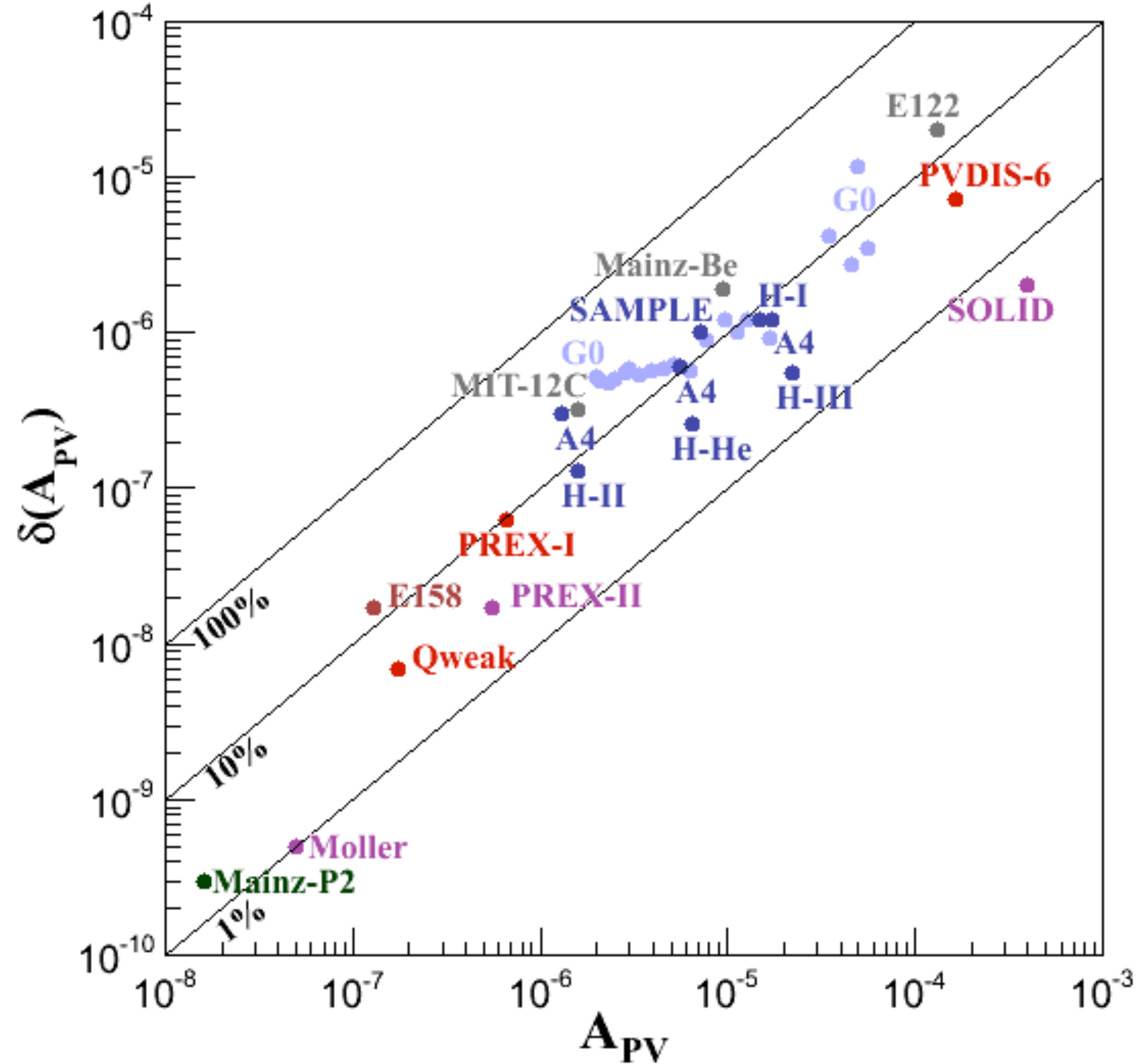

# High Precision

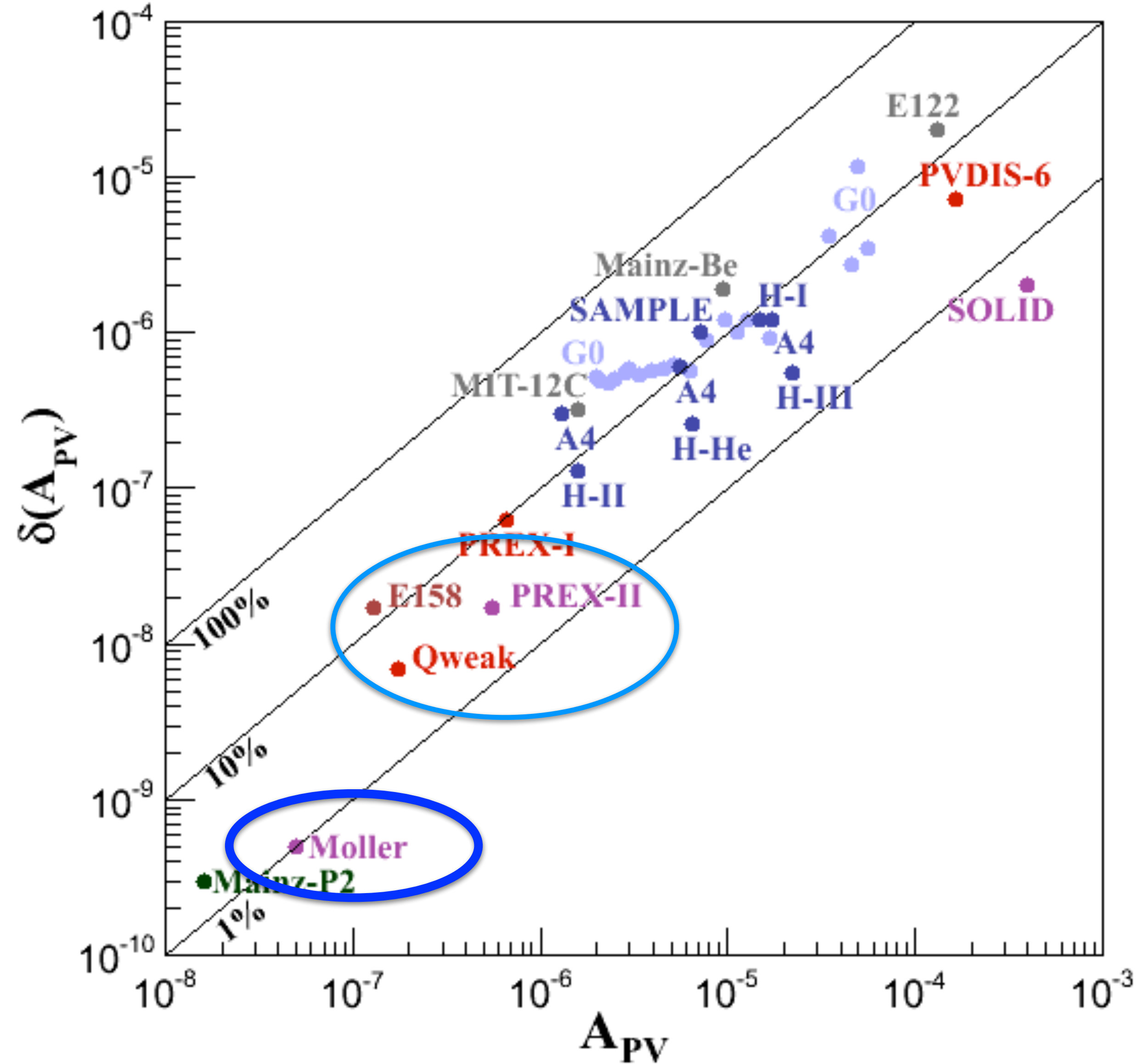

# Experimental Overview

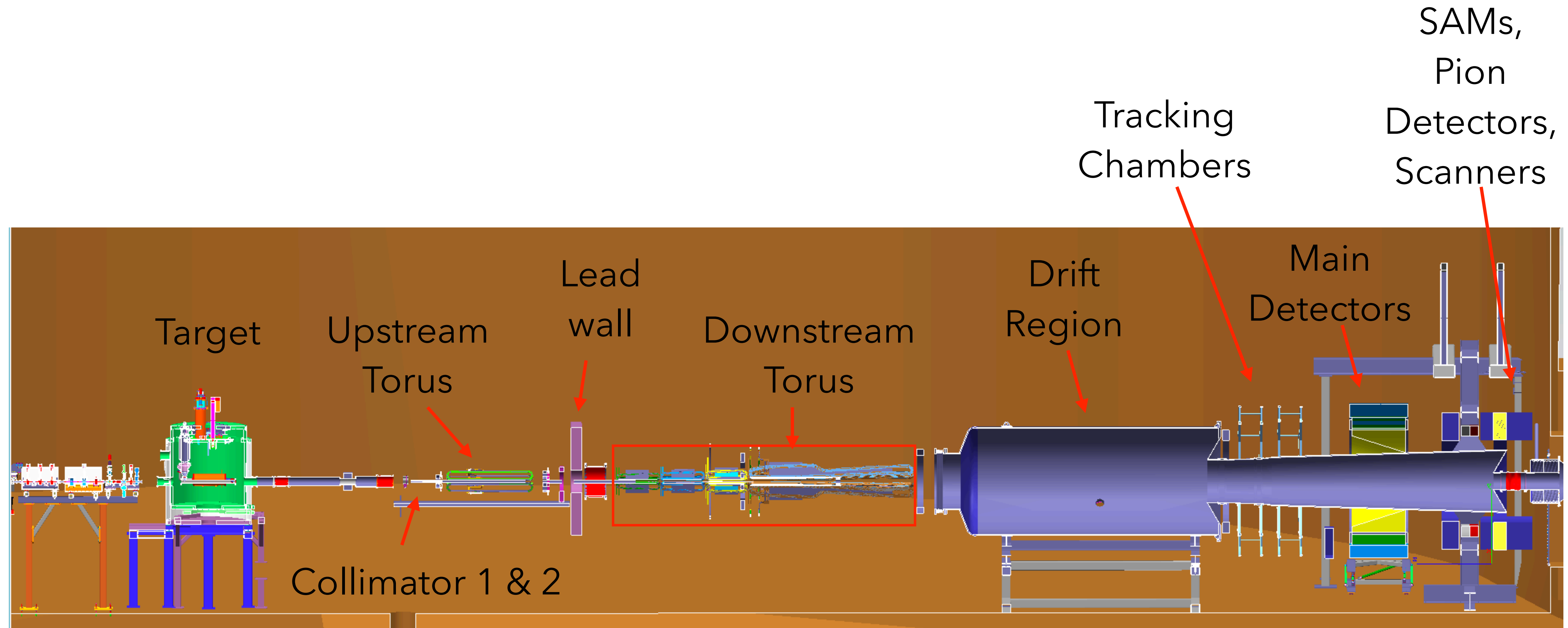



# Figure of Merit

$$A_{PV} = \frac{\sigma_R - \sigma_L}{\sigma_R + \sigma_L} = mE \frac{G_F}{\sqrt{2}\pi\alpha} \frac{4 \sin^2 \theta}{(3 + \cos^2 \theta)^2} Q_W^e$$

Highest figure of merit at  $\theta_{CM} = 90^\circ$

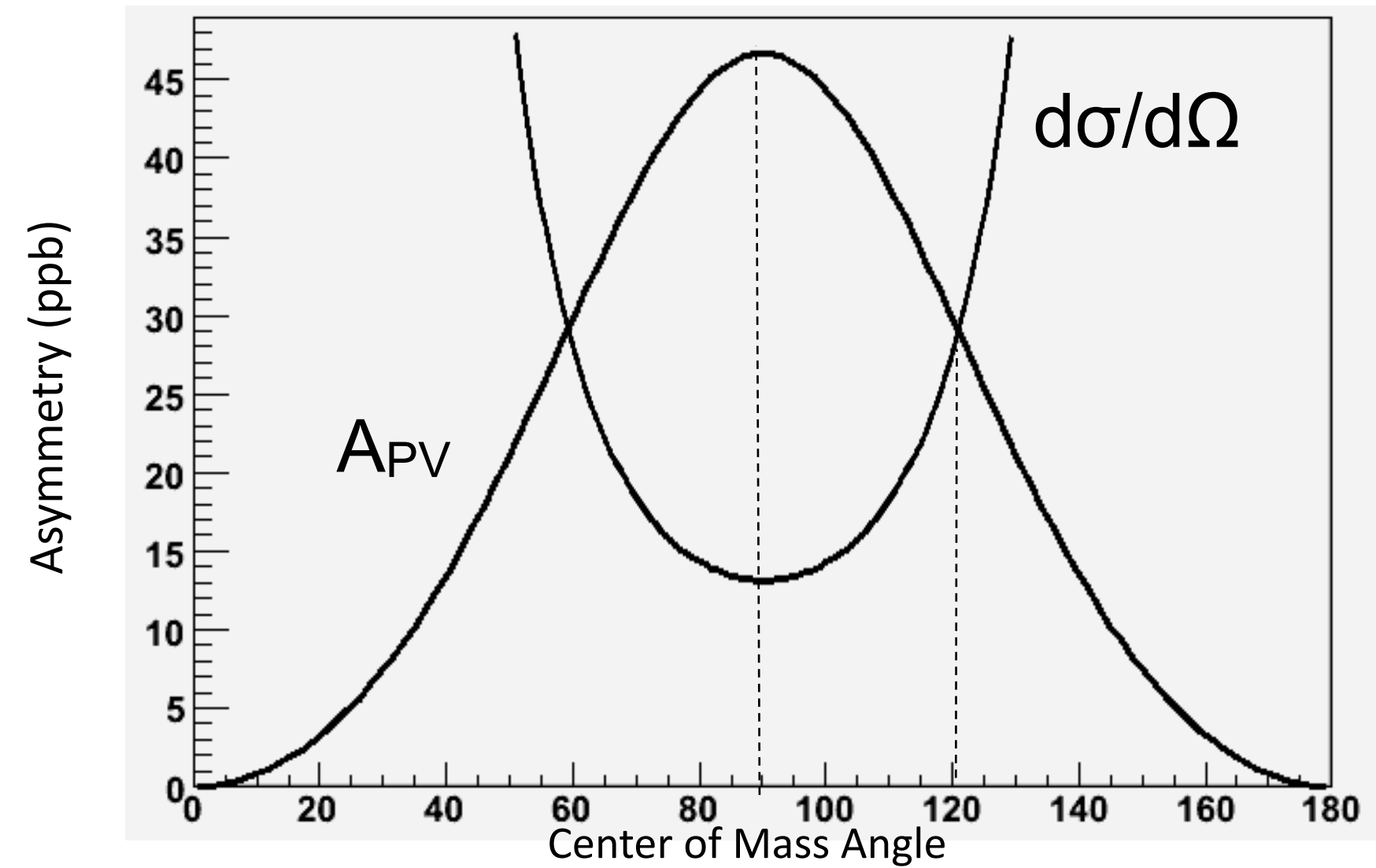

# Figure of Merit

$$A_{PV} = \frac{\sigma_R - \sigma_L}{\sigma_R + \sigma_L} = mE \frac{G_F}{\sqrt{2}\pi\alpha} \frac{4 \sin^2 \theta}{(3 + \cos^2 \theta)^2} Q_W^e$$

Highest figure of merit at  $\theta_{CM} = 90^\circ$

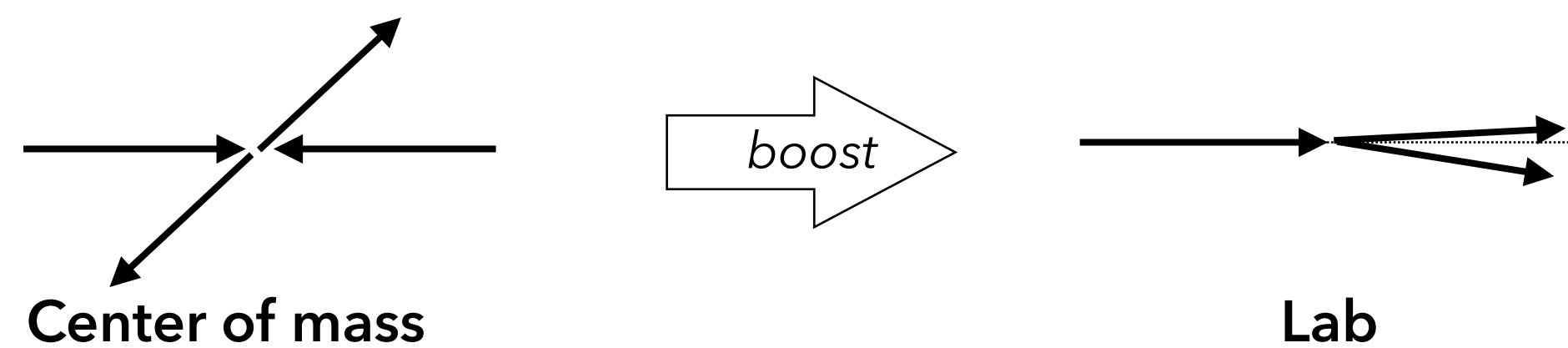
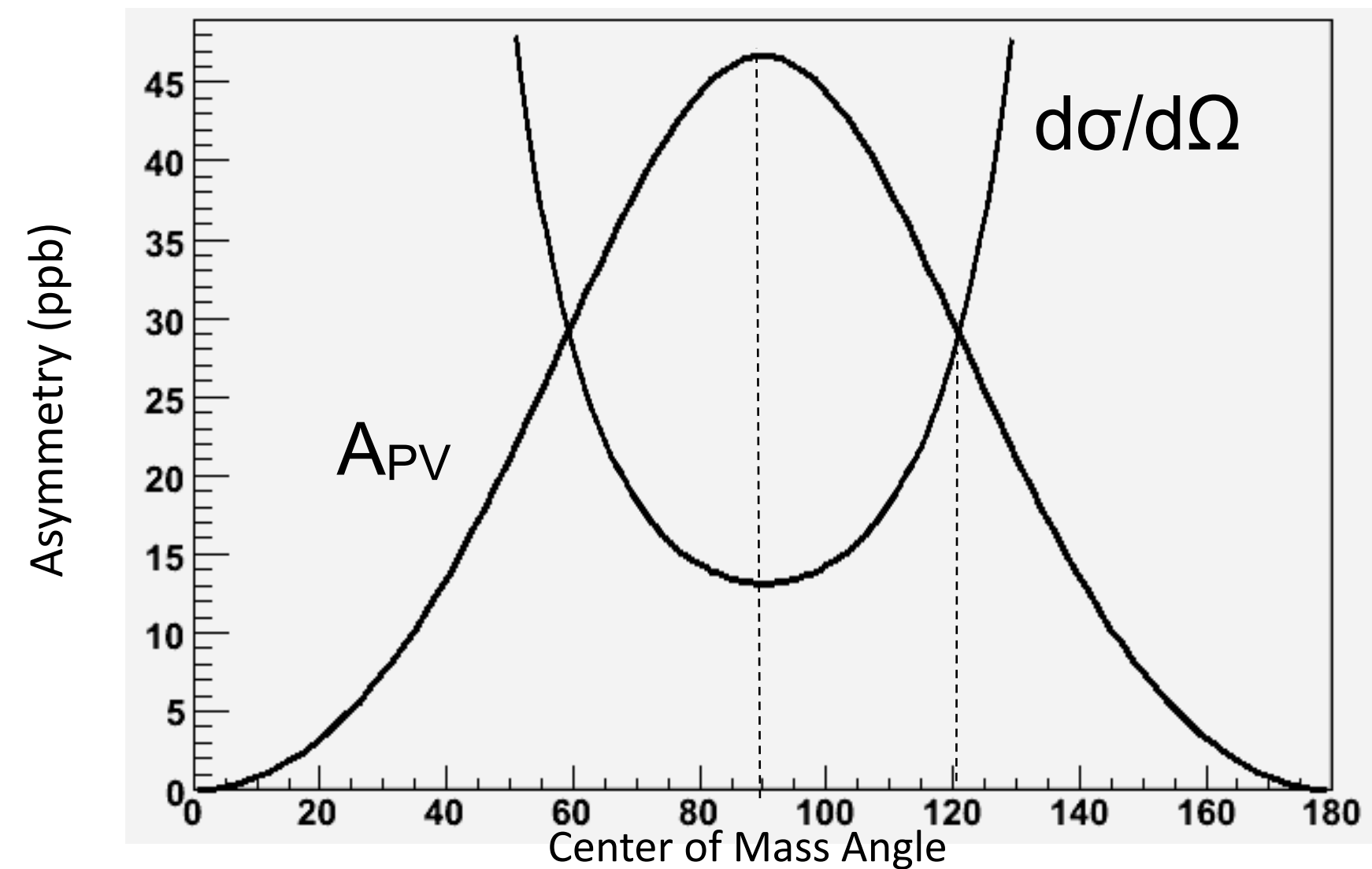

# Figure of Merit

$$A_{PV} = \frac{\sigma_R - \sigma_L}{\sigma_R + \sigma_L} = mE \frac{G_F}{\sqrt{2}\pi\alpha} \frac{4 \sin^2 \theta}{(3 + \cos^2 \theta)^2} Q_W^e$$

Highest figure of merit at  $\theta_{CM} = 90^\circ$

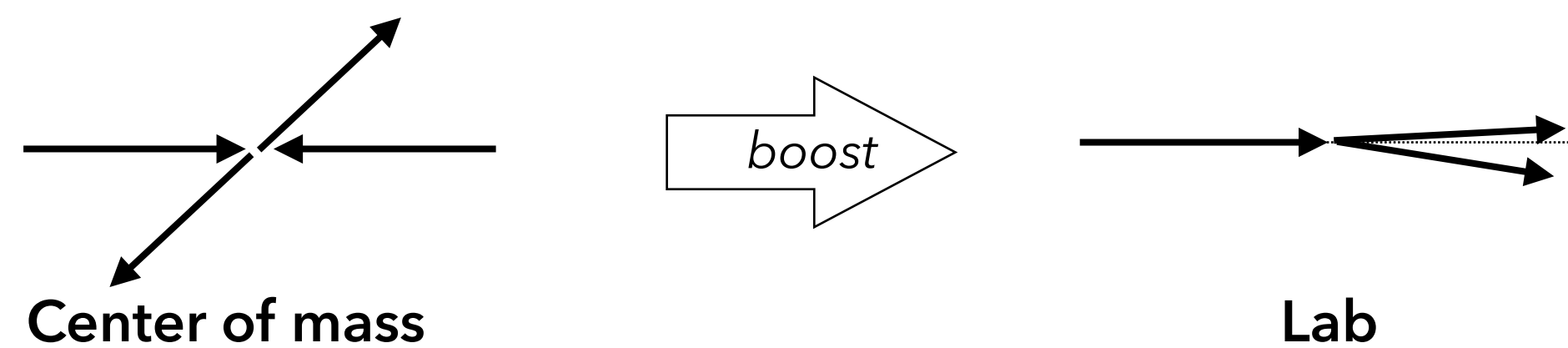
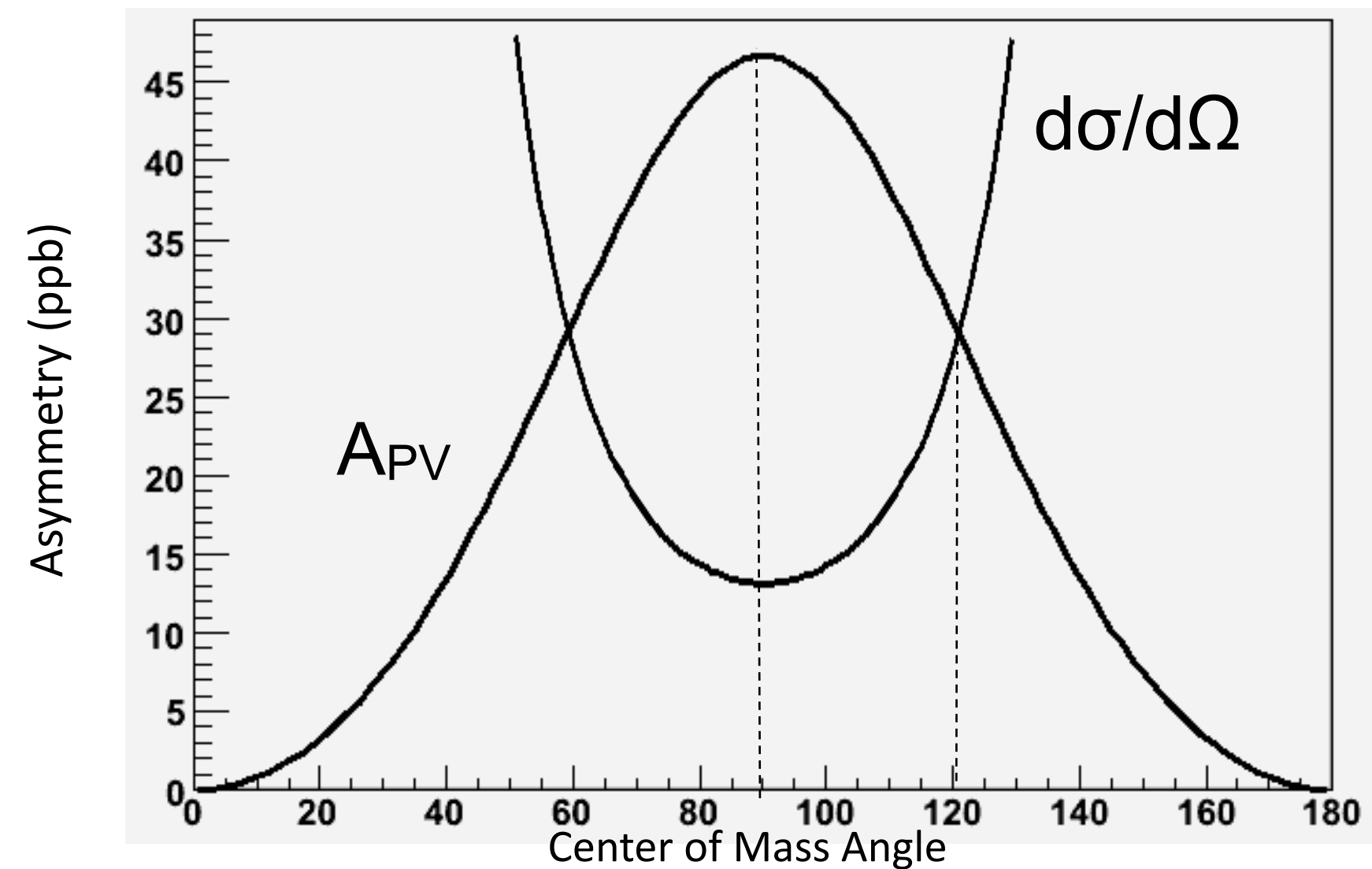

Identical particles.

Measure either forward or backward scattering.

# Figure of Merit

$$A_{PV} = \frac{\sigma_R - \sigma_L}{\sigma_R + \sigma_L} = mE \frac{G_F}{\sqrt{2}\pi\alpha} \frac{4 \sin^2 \theta}{(3 + \cos^2 \theta)^2} Q_W^e$$

Highest figure of merit at  $\theta_{CM} = 90^\circ$

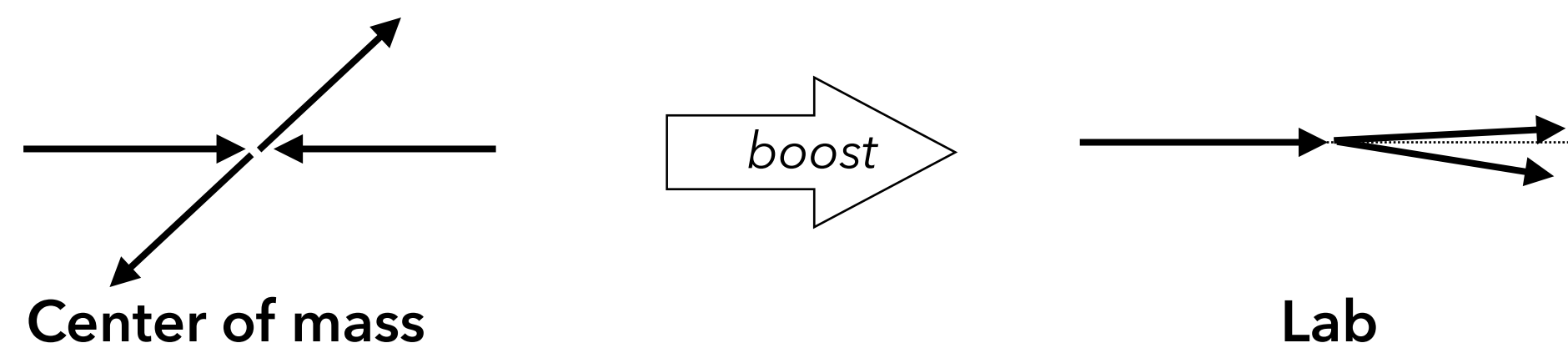
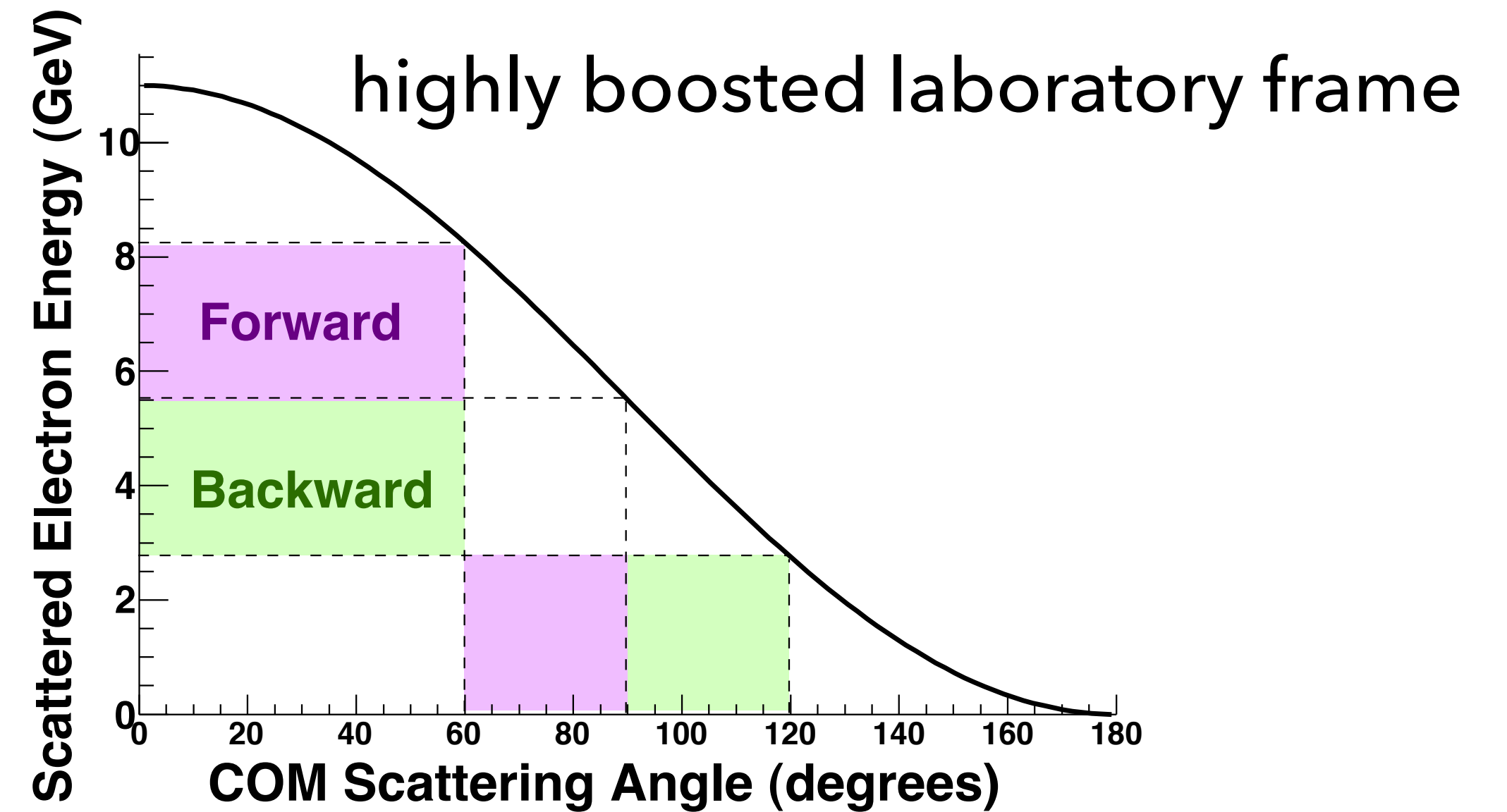
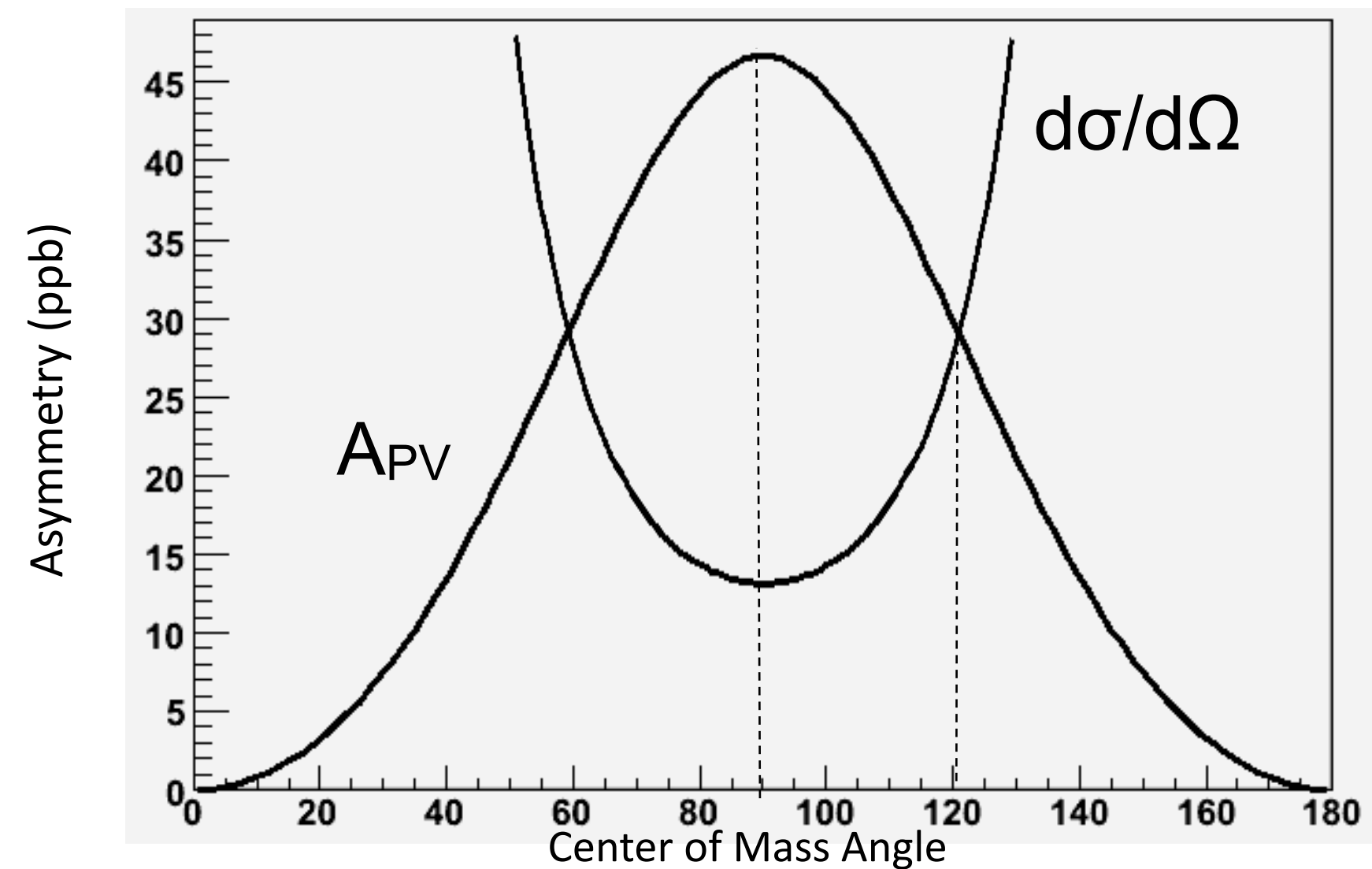

Identical particles.

Measure either forward or backward scattering.

# Figure of Merit

$$A_{PV} = \frac{\sigma_R - \sigma_L}{\sigma_R + \sigma_L} = mE \frac{G_F}{\sqrt{2}\pi\alpha} \frac{4 \sin^2 \theta}{(3 + \cos^2 \theta)^2} Q_W^e$$

Highest figure of merit at  $\theta_{CM} = 90^\circ$

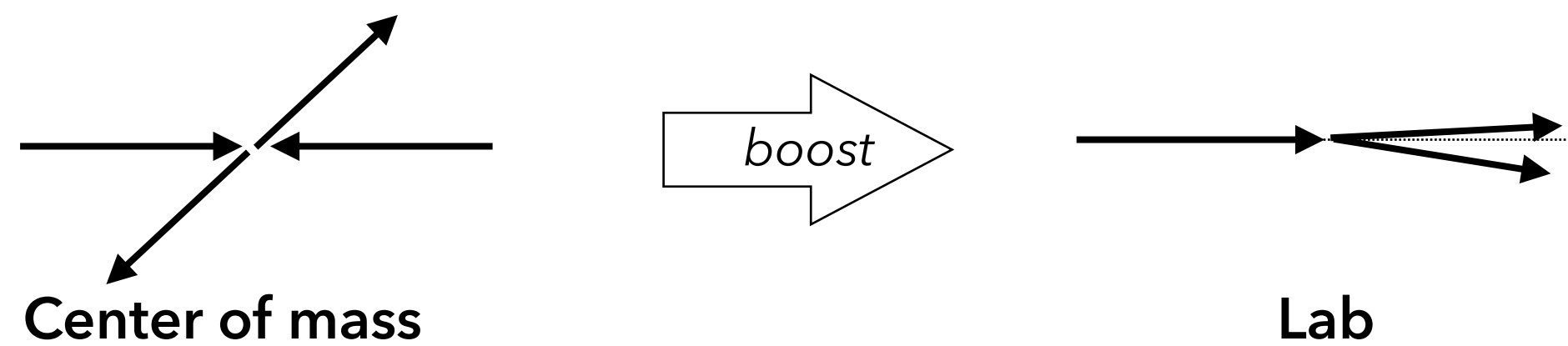
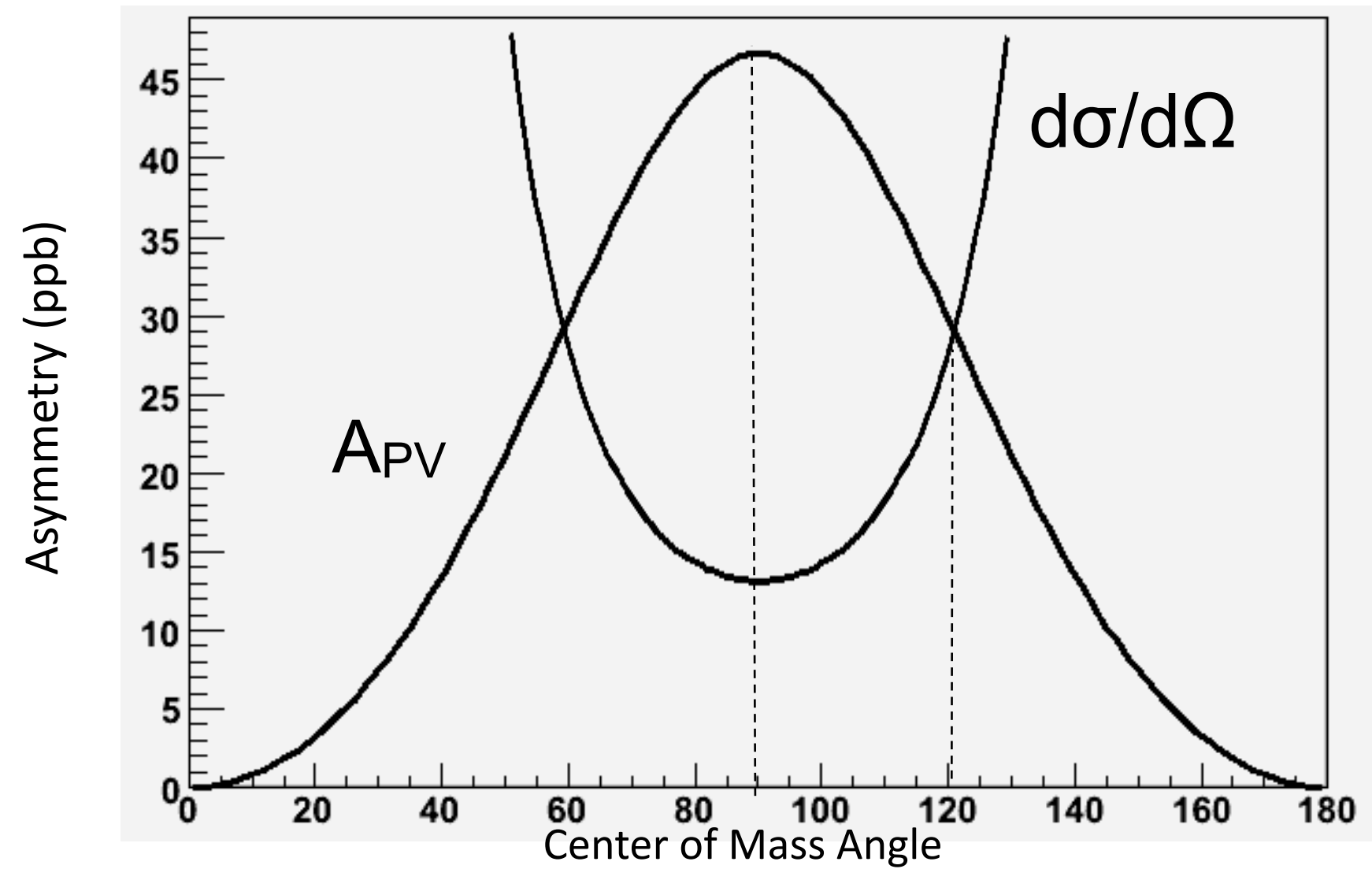

Identical particles.

Measure either forward or backward scattering.

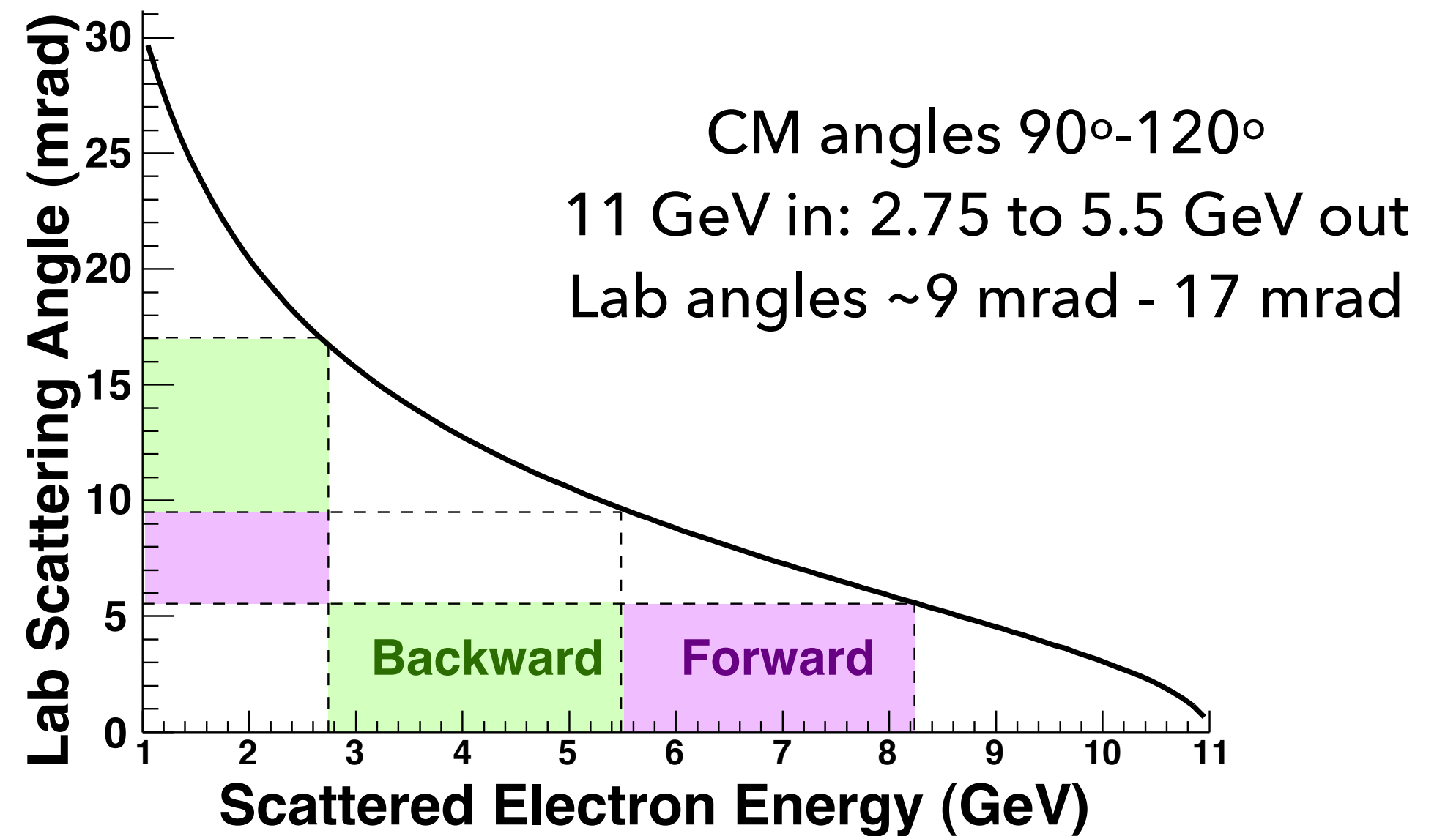
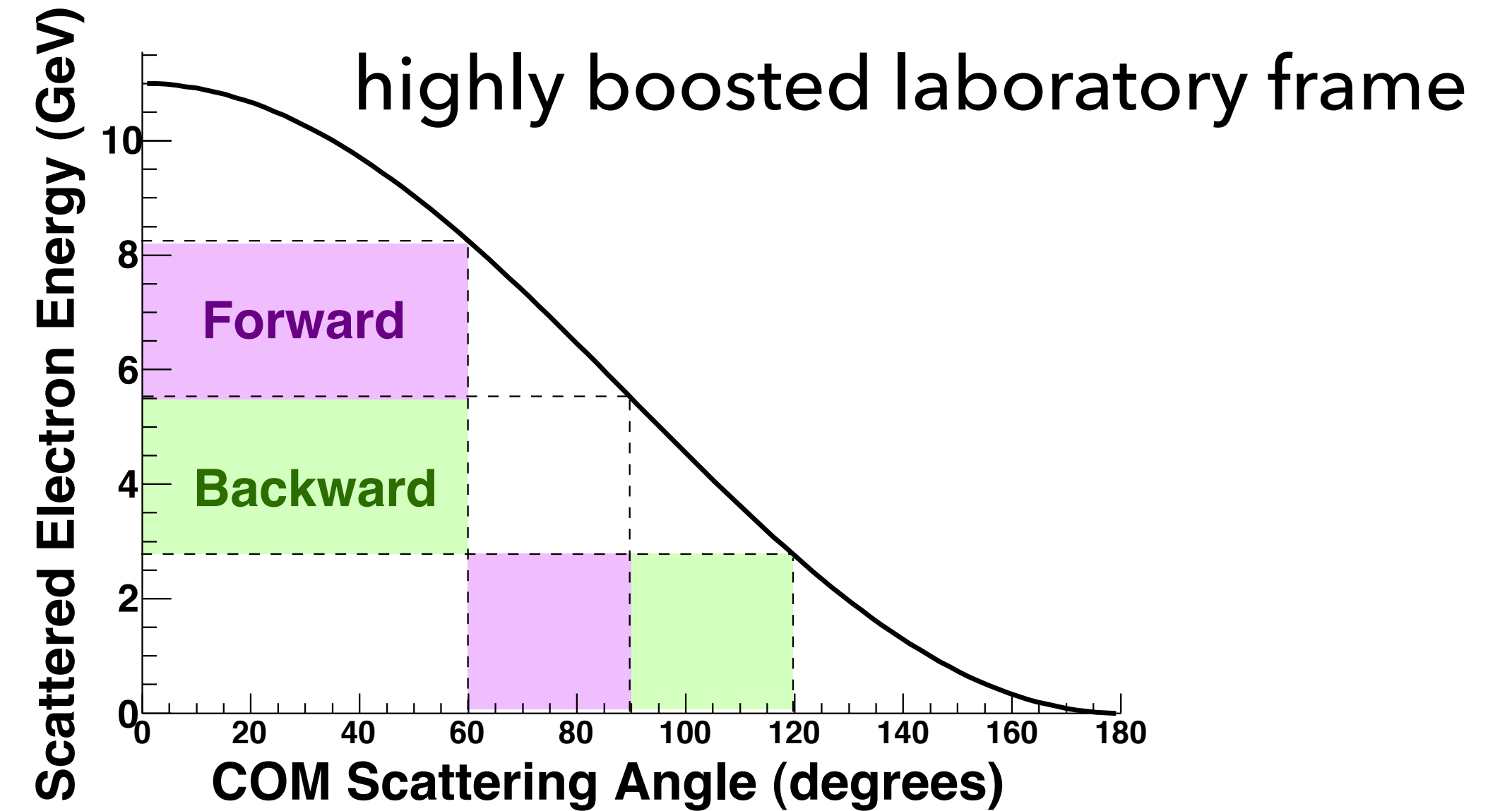

# Identical Particles

Since you only need either the forward or the backward scatter, accept forward+backward for half the azimuth

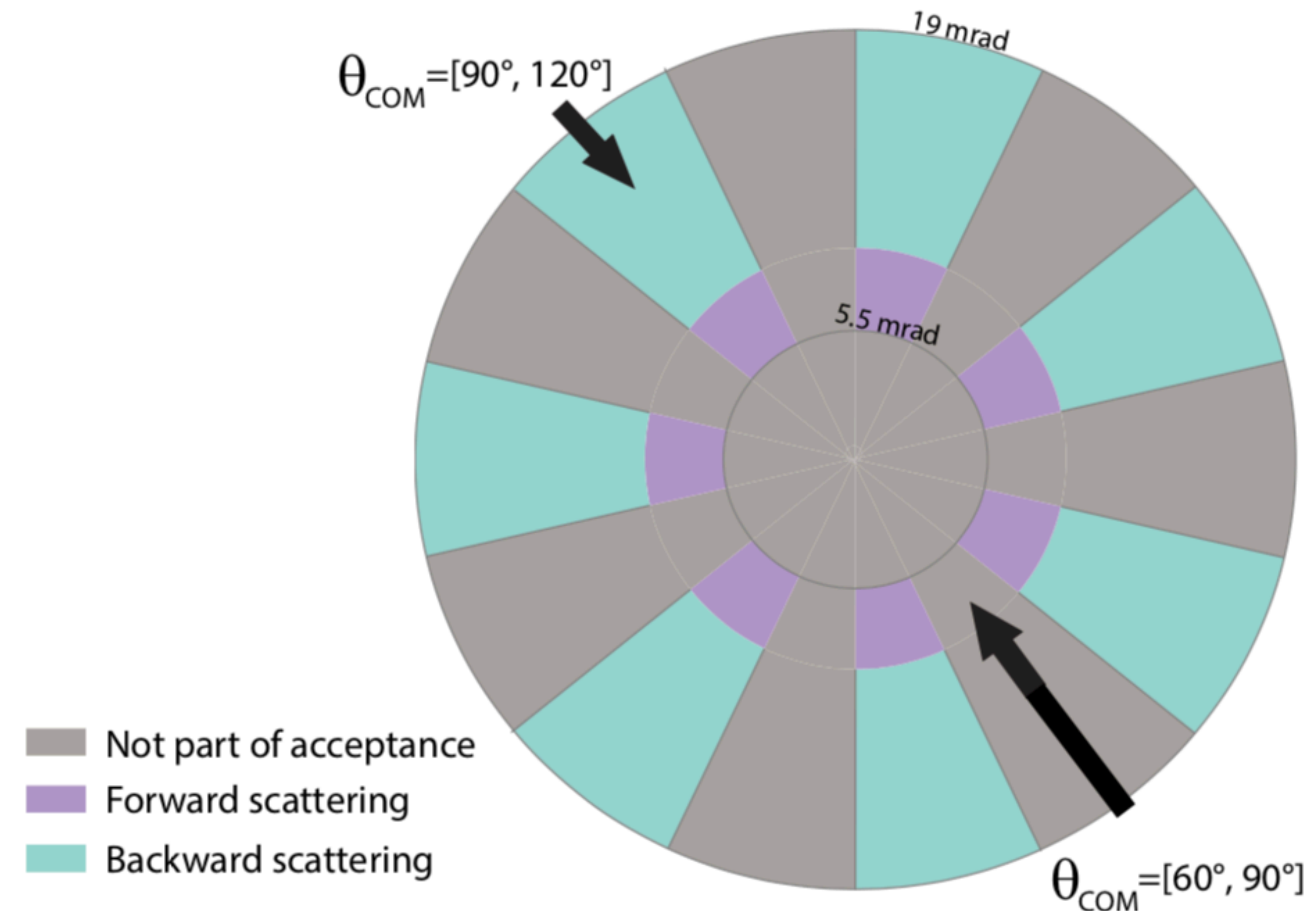
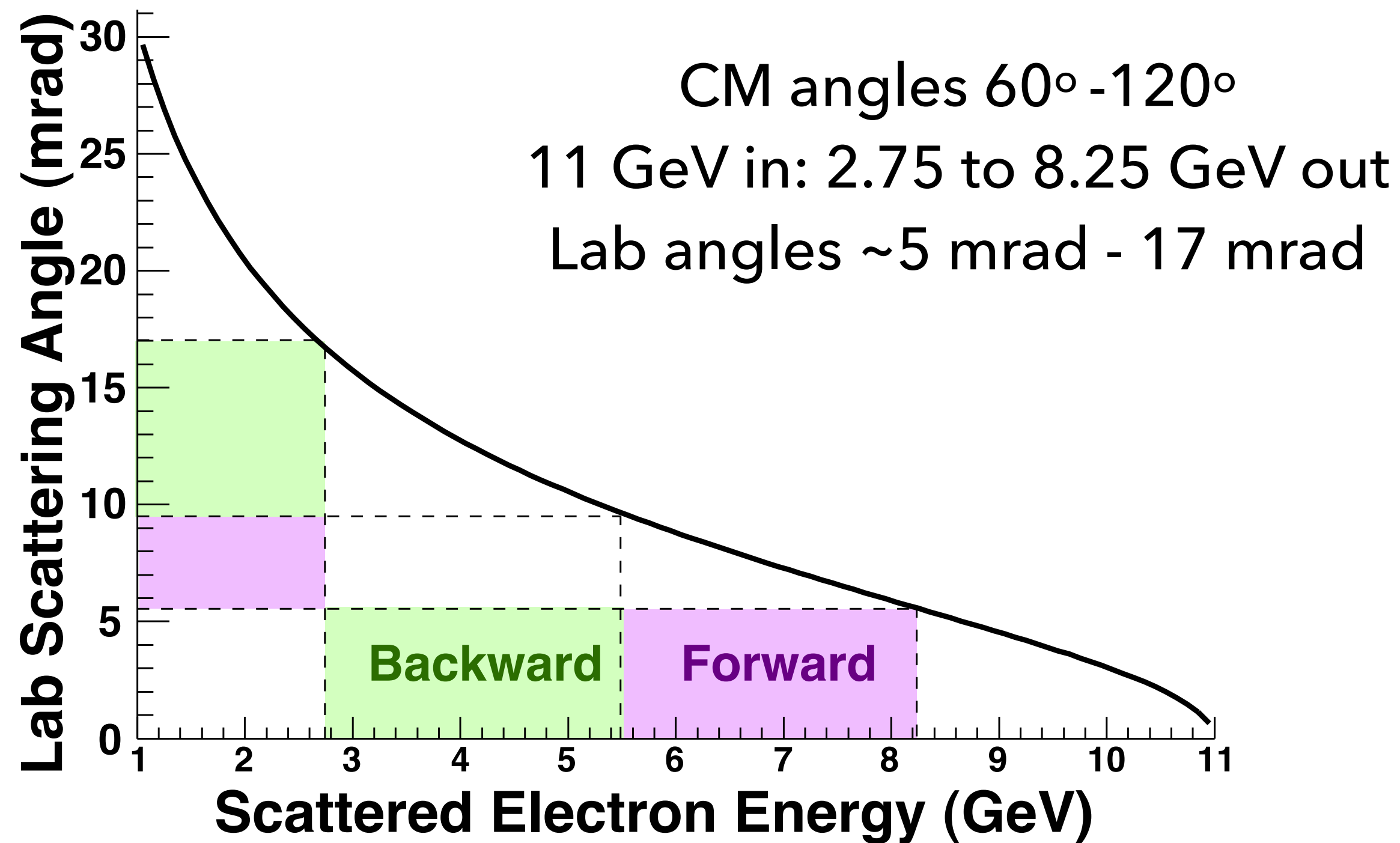

Unique concept allows for full azimuthal acceptance (effectively) even leaving space for coils but makes for a challenging design

# Spectrometer Concept

- Bend scattered particles, separate ee from ep and photons
- Small angles and high beam power
- Large energy range (3-8 GeV)
- Long target

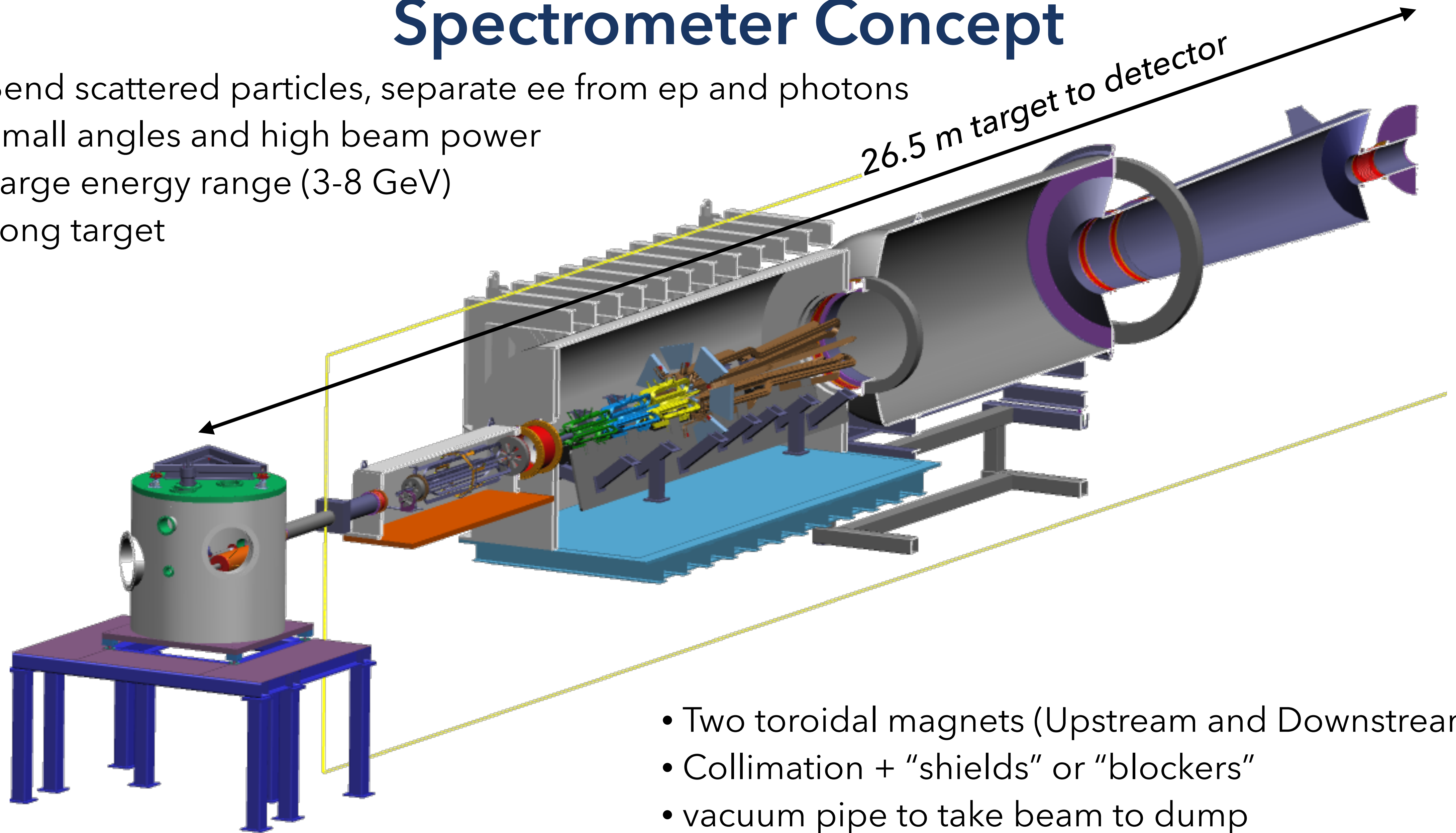

- Two toroidal magnets (Upstream and Downstream)
- Collimation + "shields" or "blockers"
- vacuum pipe to take beam to dump

# Radial and Azimuthal Fields

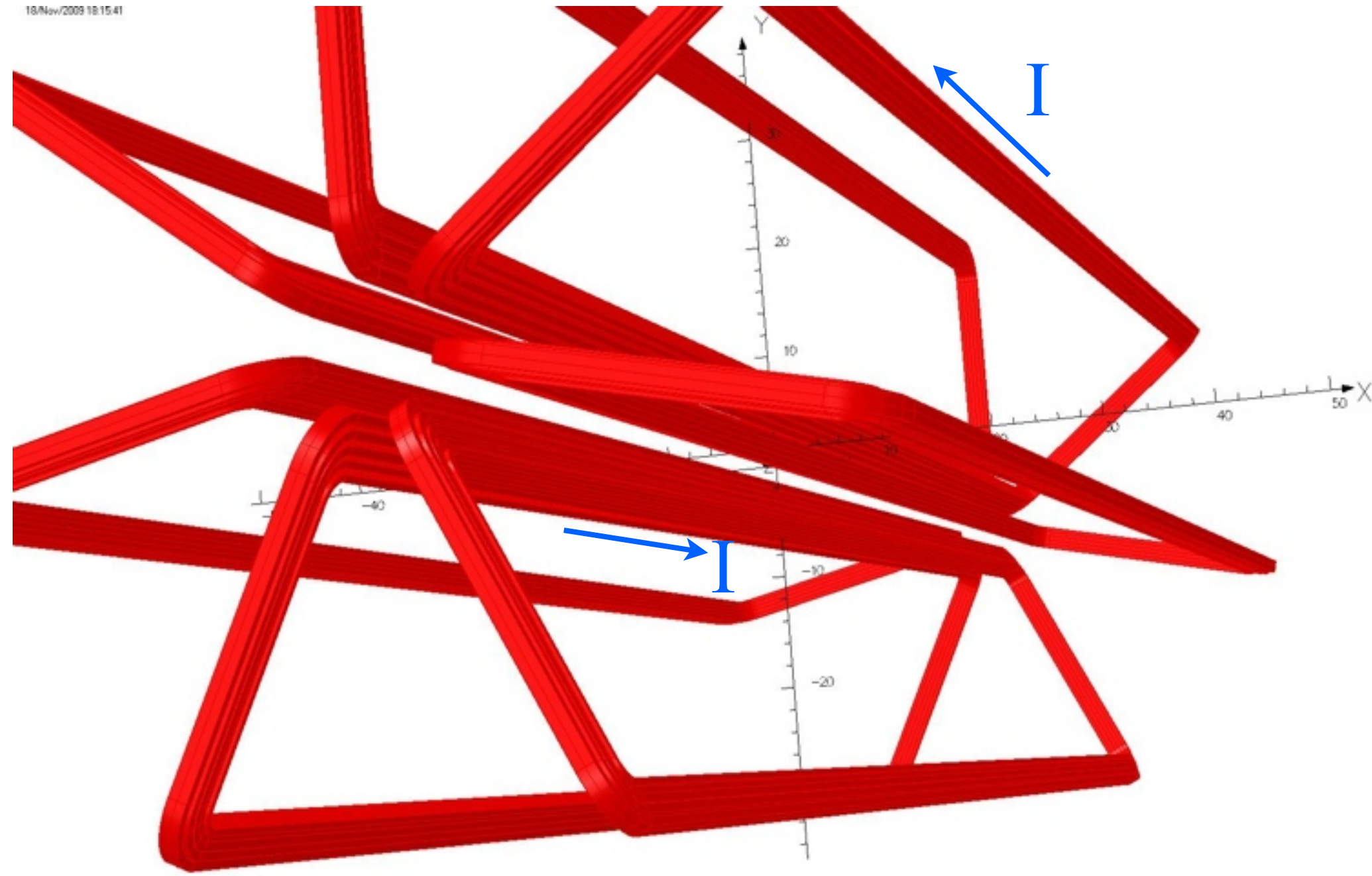

**Effectively focuses or defocusses azimuthally!**

**Inner and outer edges of toroids have significant radial field components**

Radial field component vs. radius off-center of open sector

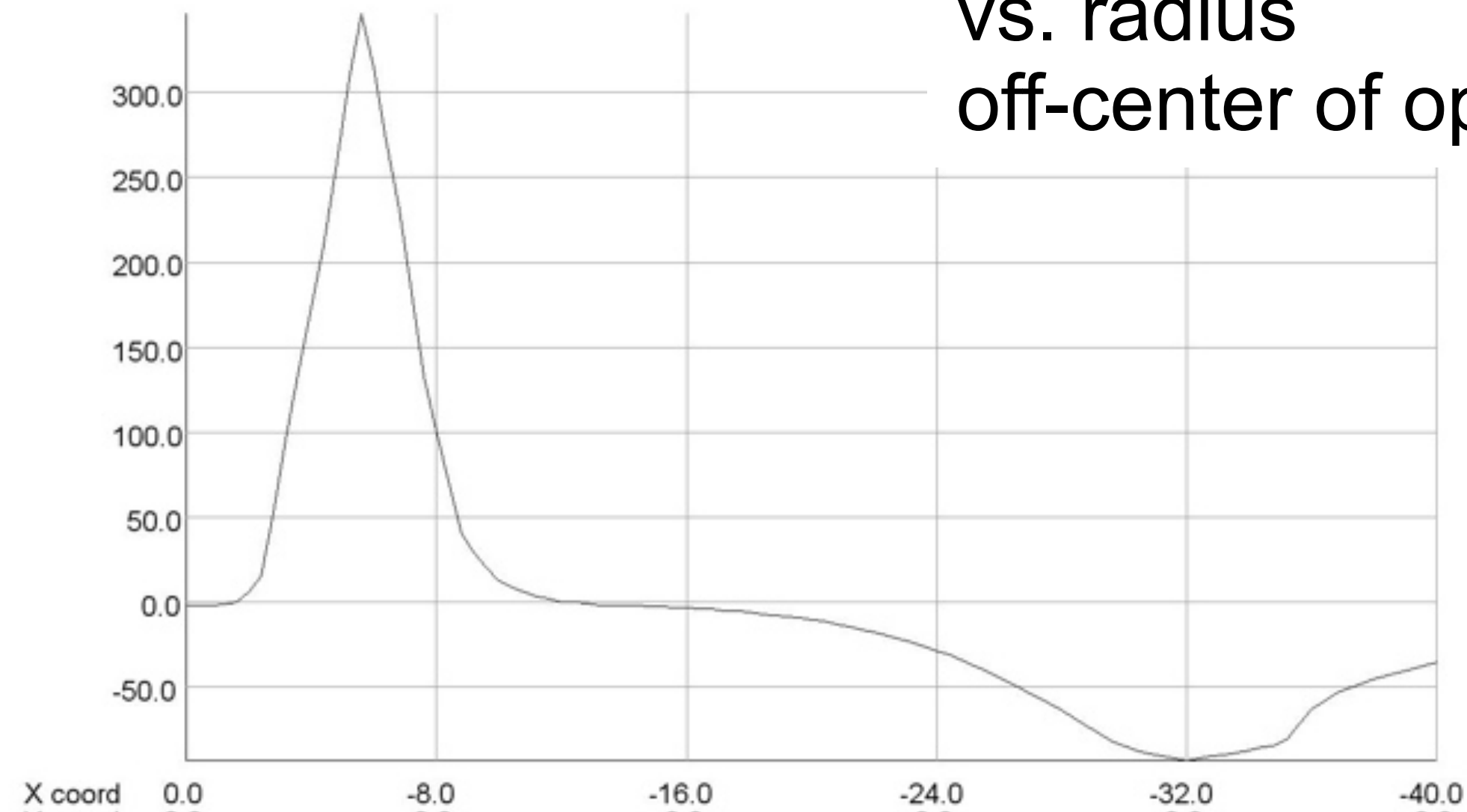

repels electrons from coil  
“focussing”

attracts electrons toward coils  
“defocussing”



# Magnet Concept

long and skinny



0.5 x 2m

0.9 x 6.5m

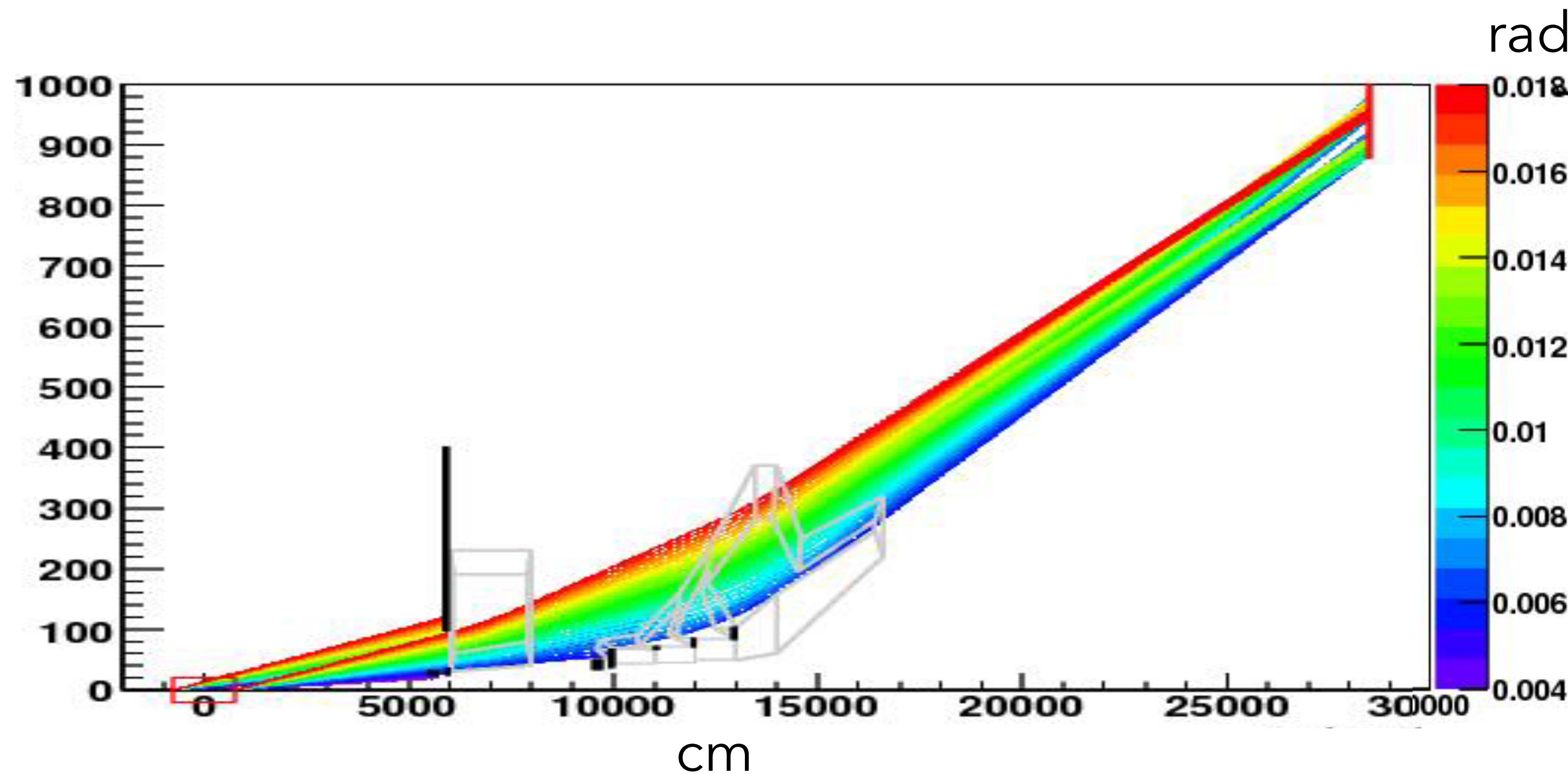
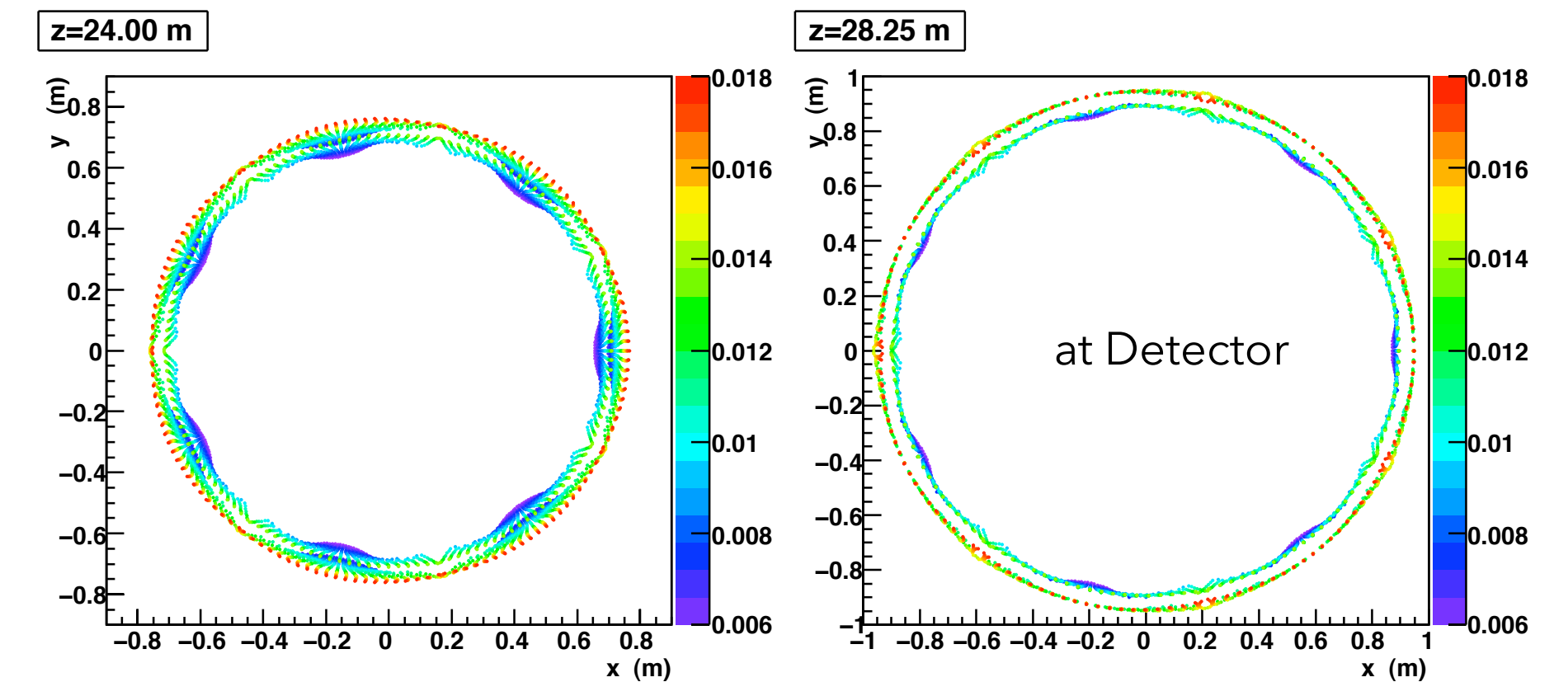
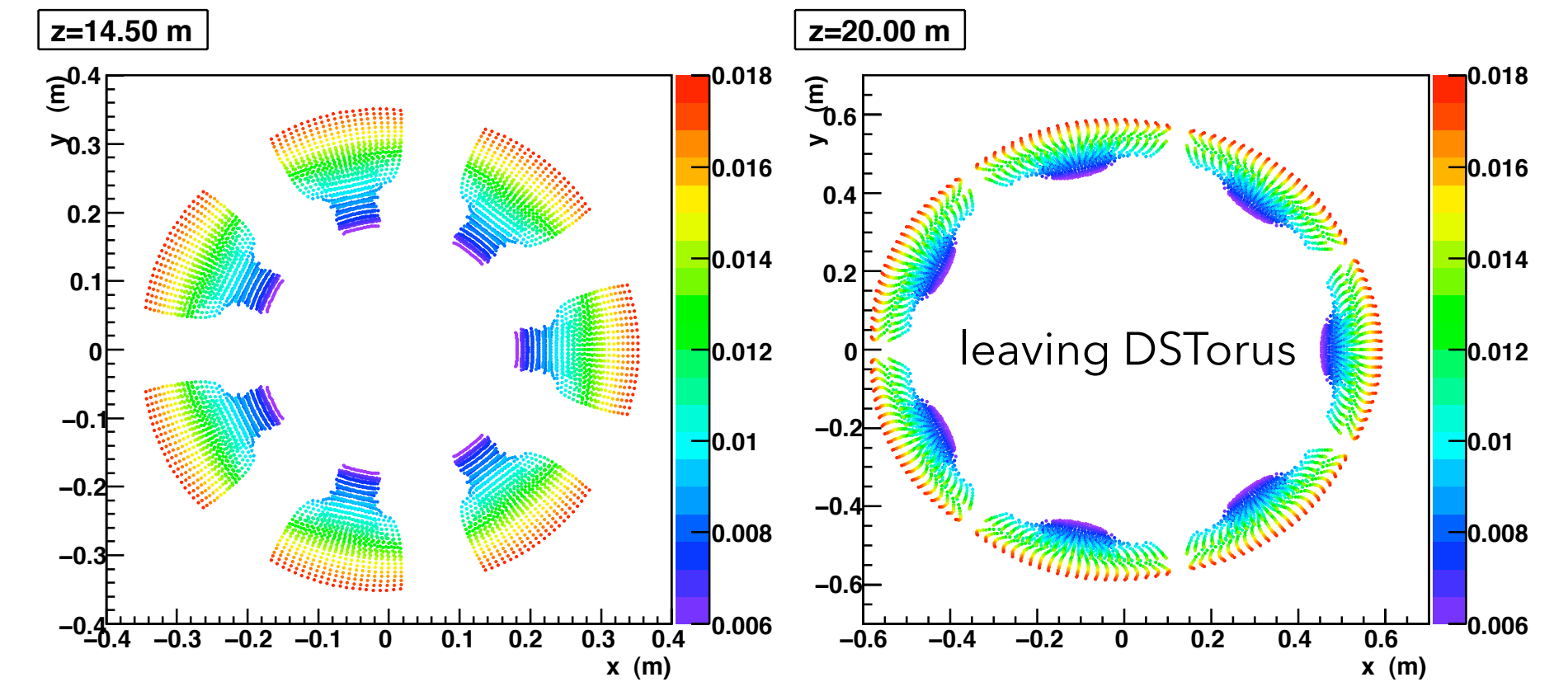
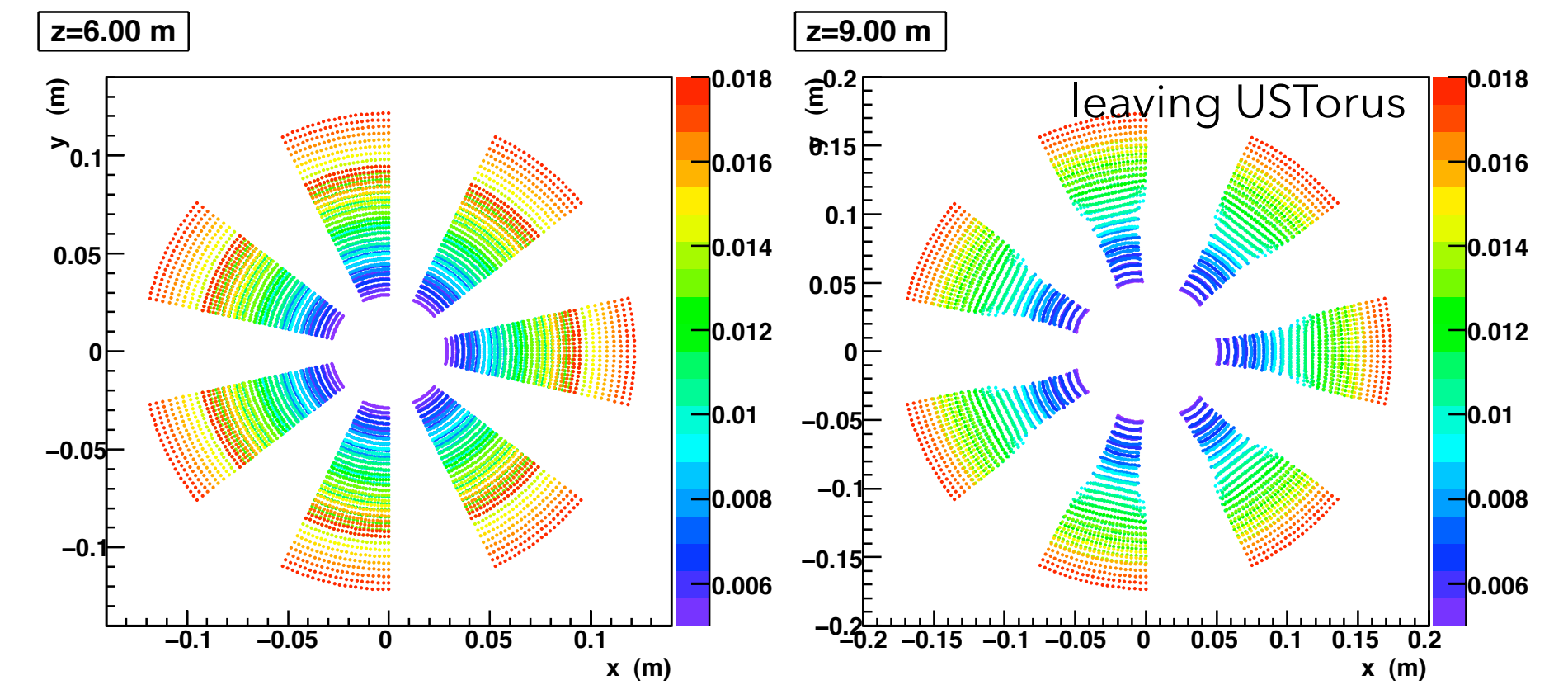

# Main Detector

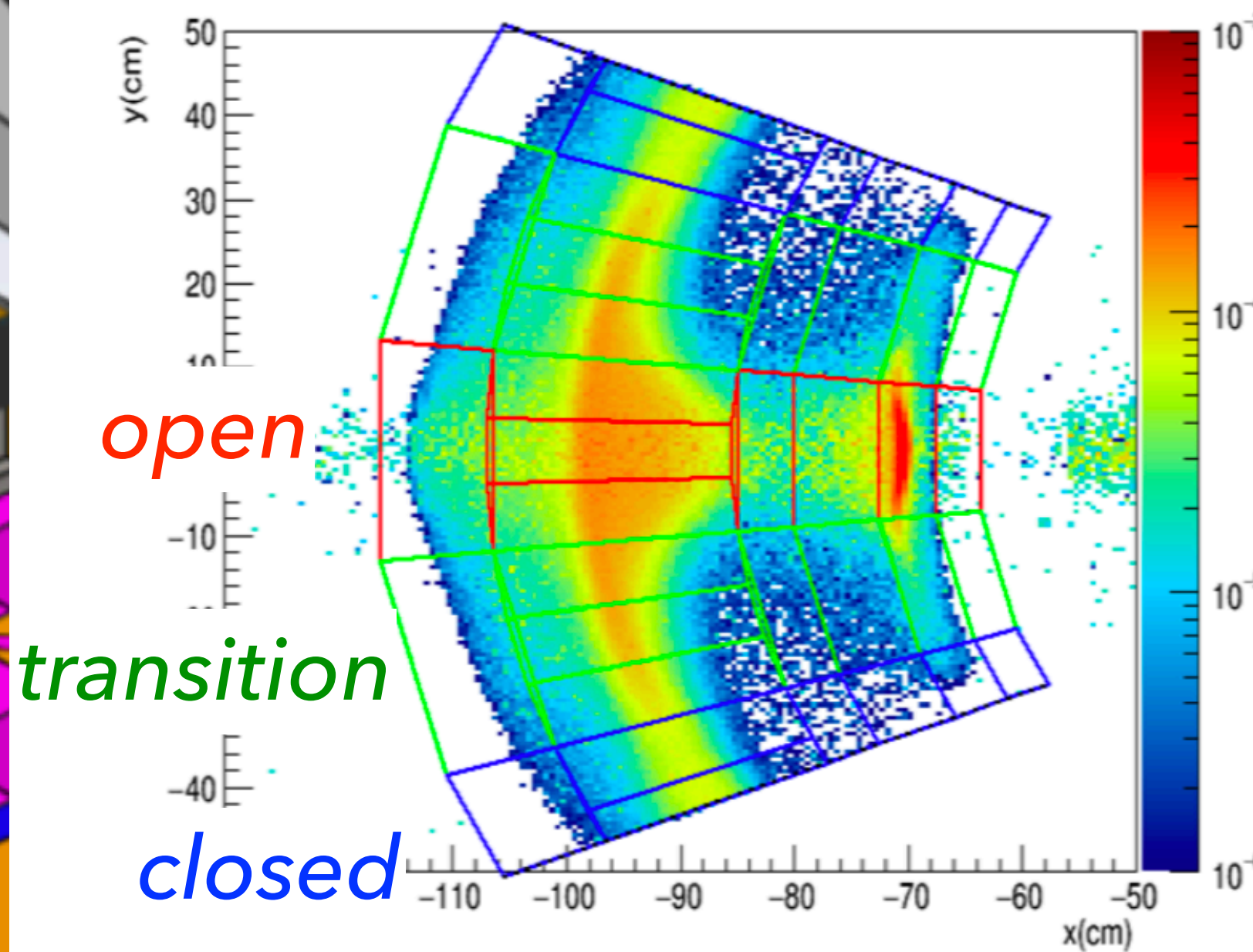
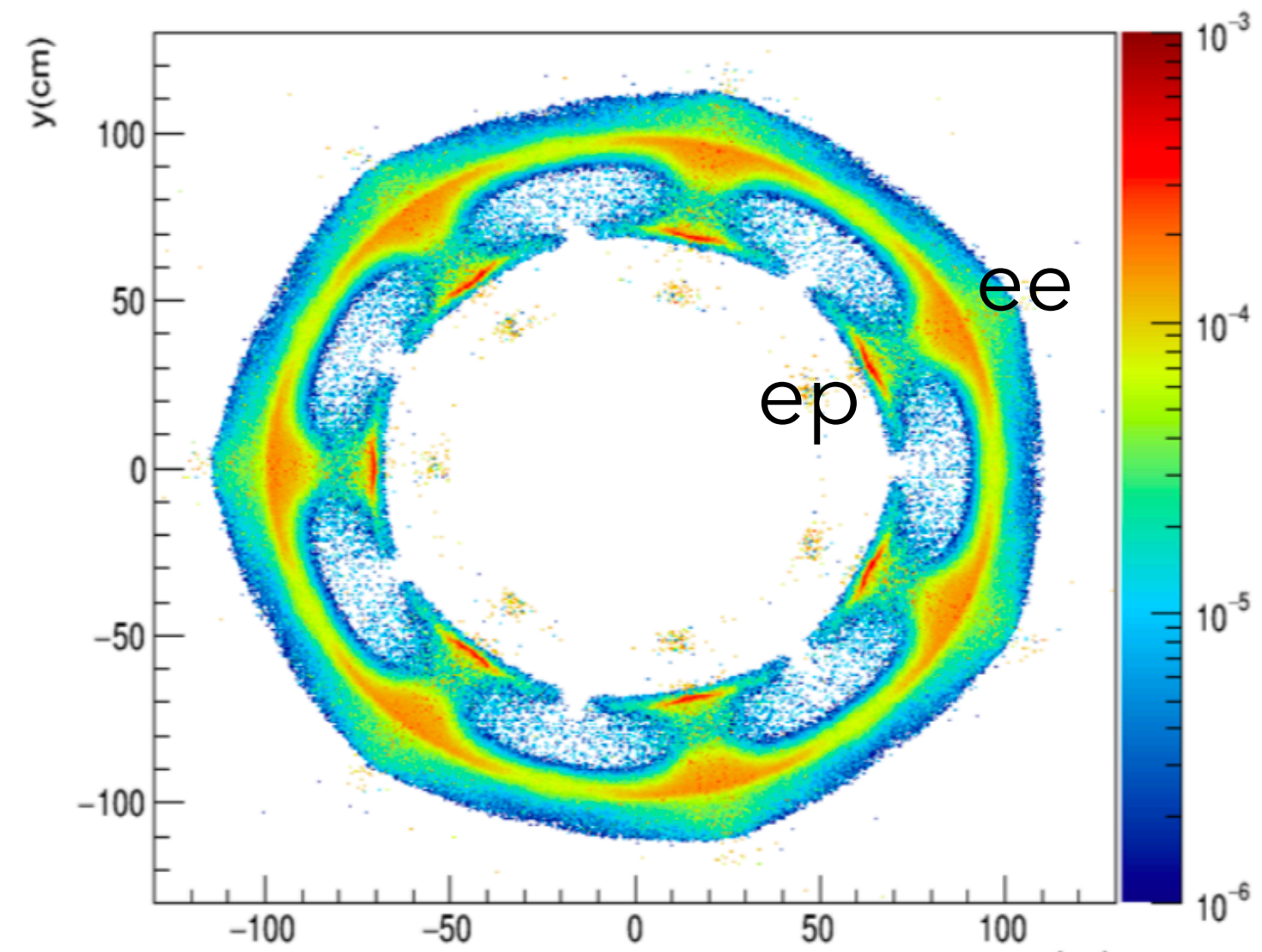
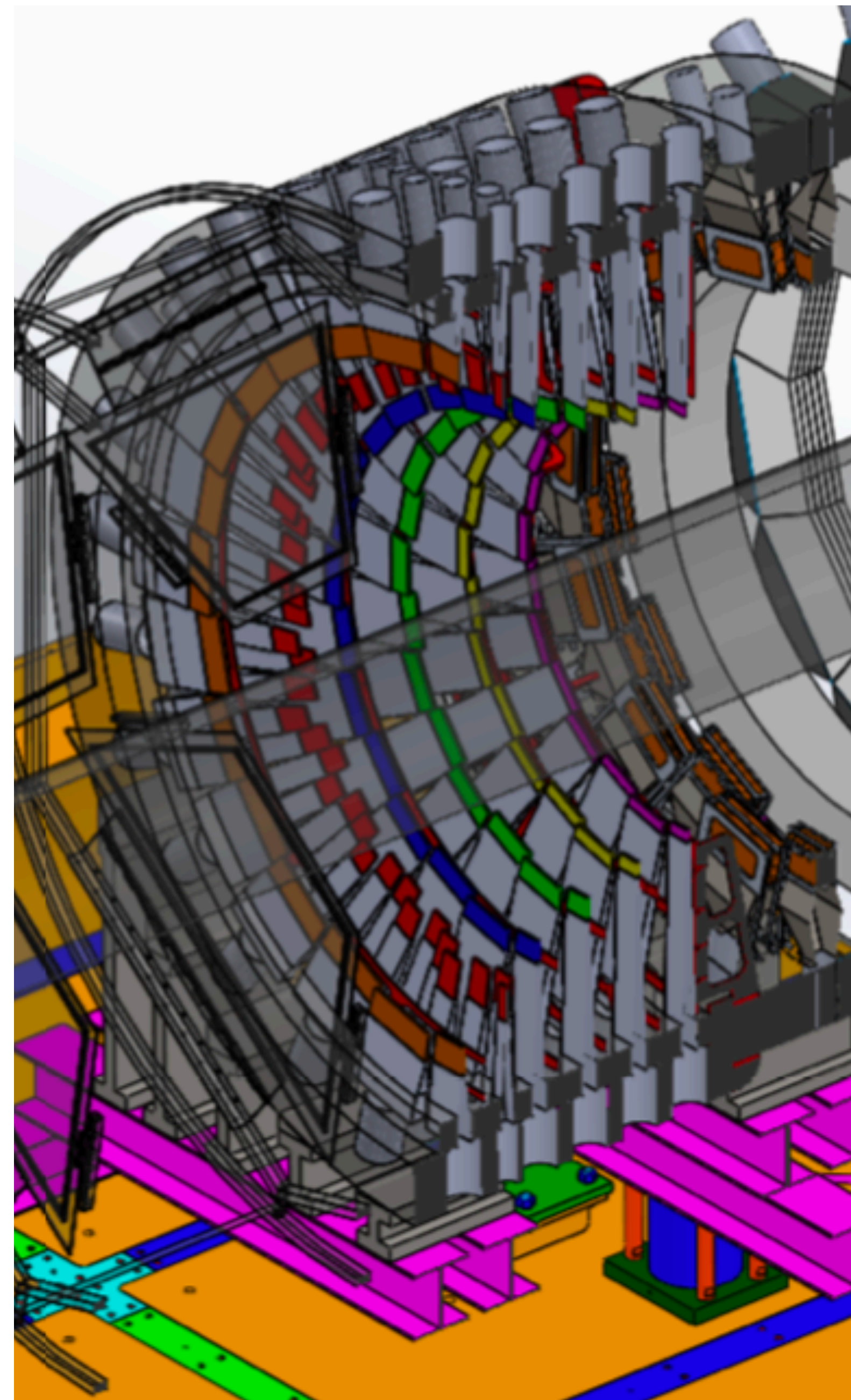

Radial distribution at detector plane 26.5 m from target

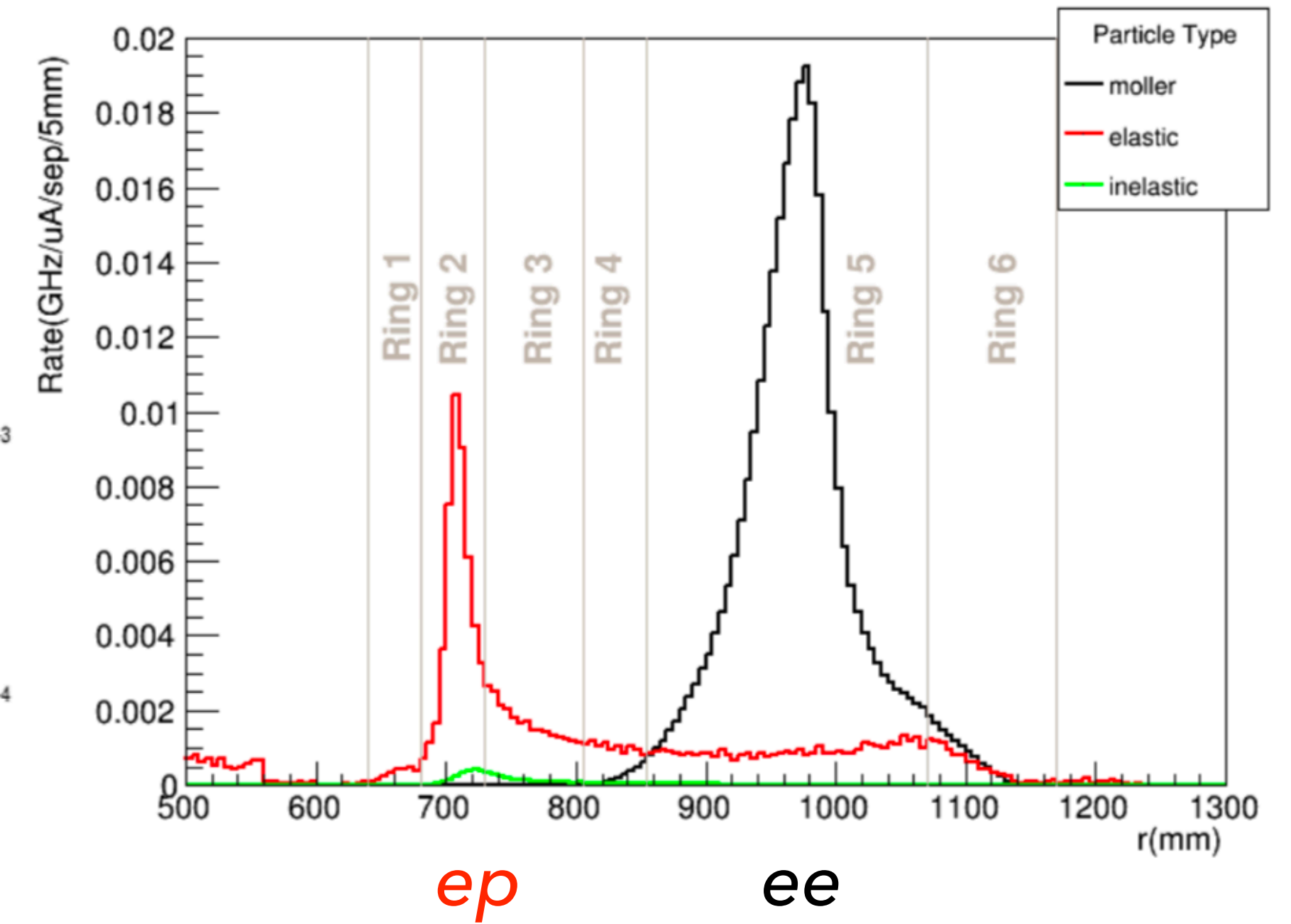

# Backgrounds (irreducible)

*Illustration with each septant a different fundamental background*

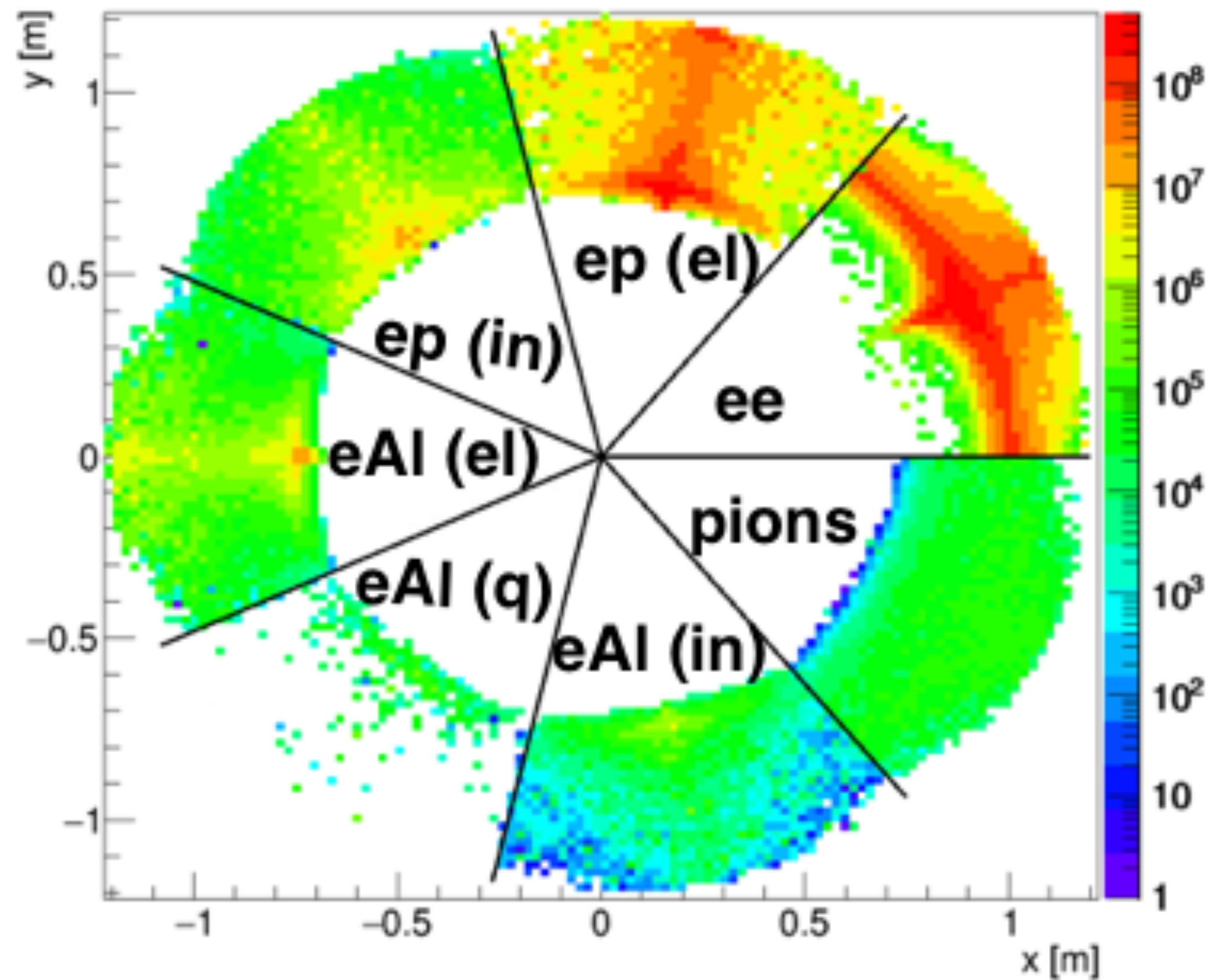

There are various sources of backgrounds arising from scattering in the target that will pass through the spectrometer and arrive at the detector plane.

We must deconvolute the signal from the background using the segmented detector plane

# Backgrounds (rescattering)

- Other backgrounds aren't directly through the acceptance channel, but are
- from rescattering of the beam as it makes its way through the spectrometer to the dump
  - from off-energy particles in the acceptance that rescatter from edges or surfaces, and go on to find the detector

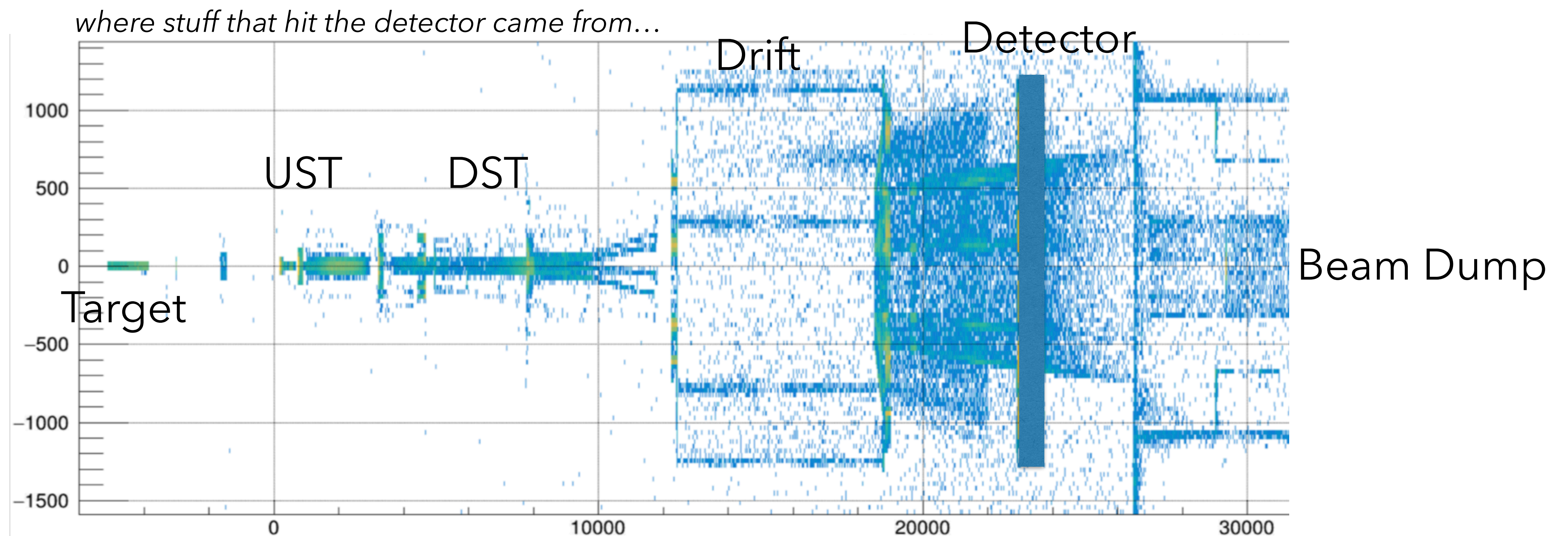

# Beam Collimation

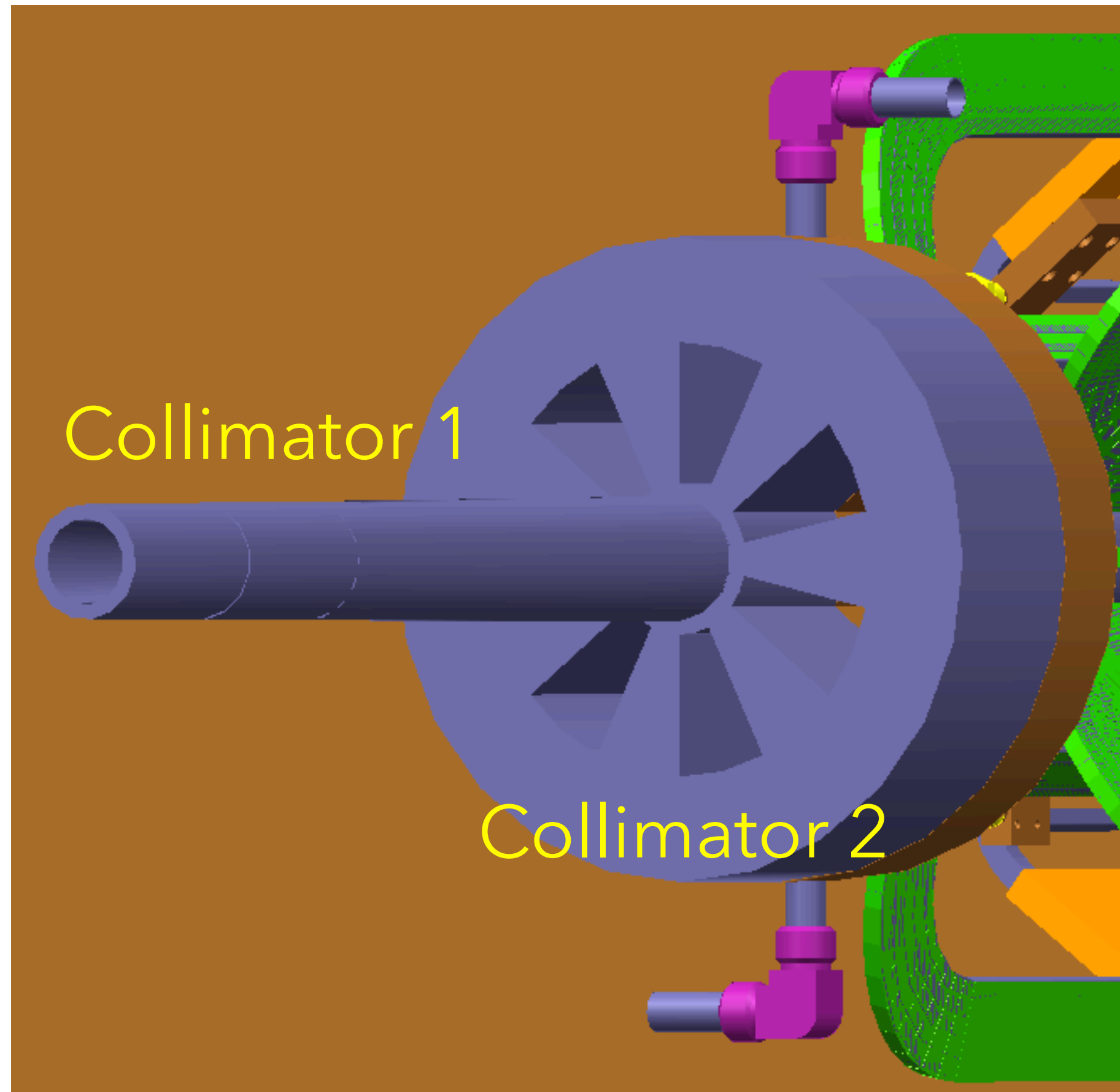

Collimator 1: long snout, collimates primary beam so what remains can go to the dump.  
~3200 W

Collimator 2: wedges define the acceptance of the 7 septants

# Walls, collars, and lintels supplement the collimation

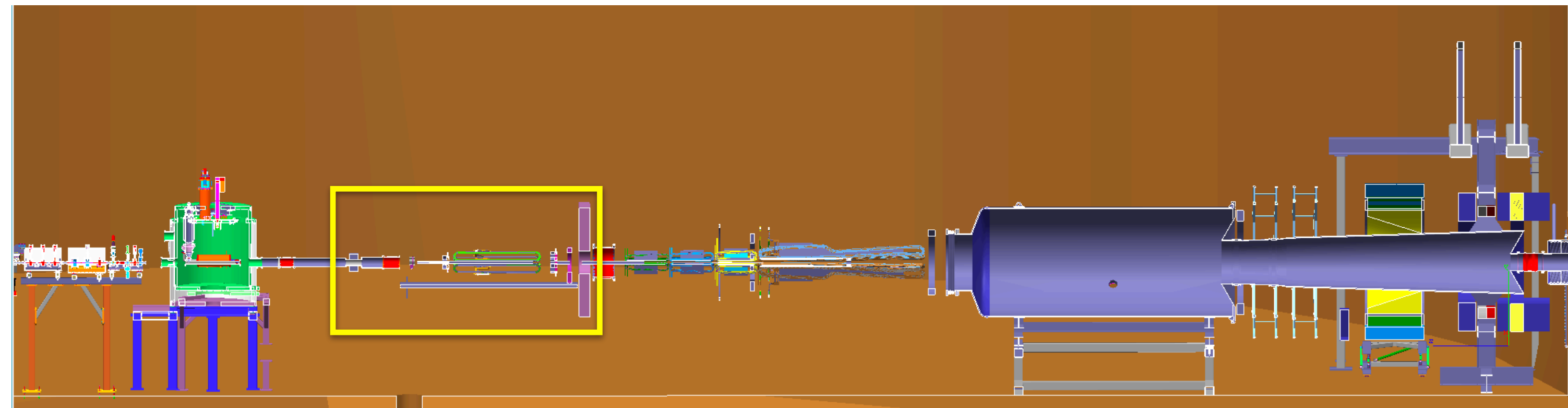
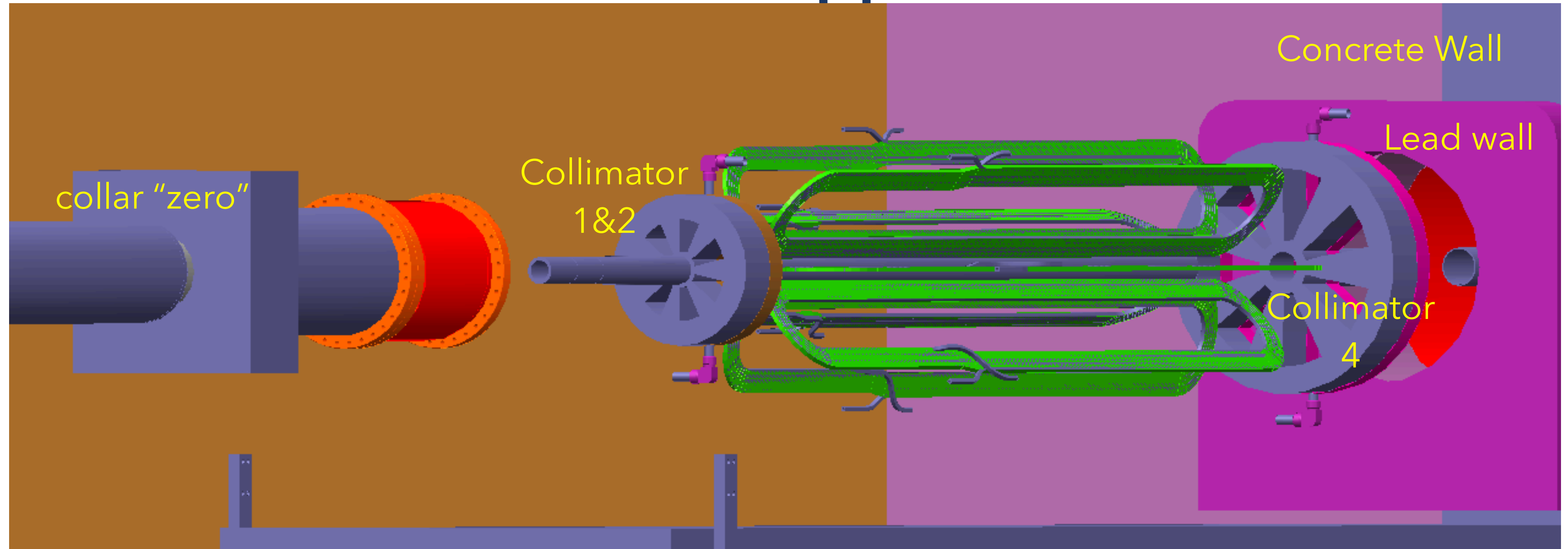

# Walls, collars, and lintels supplement the collimation

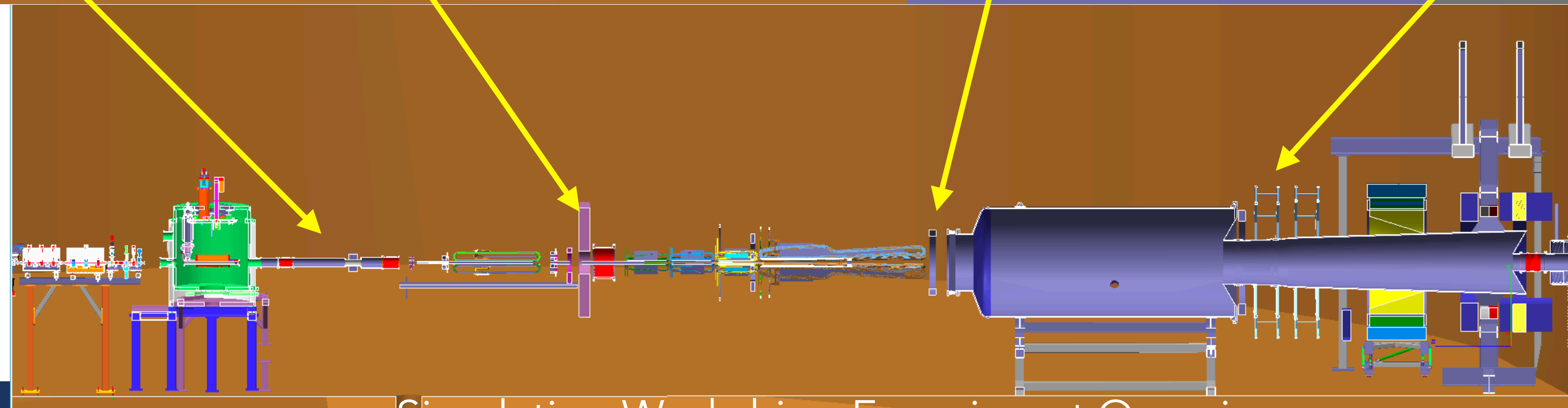
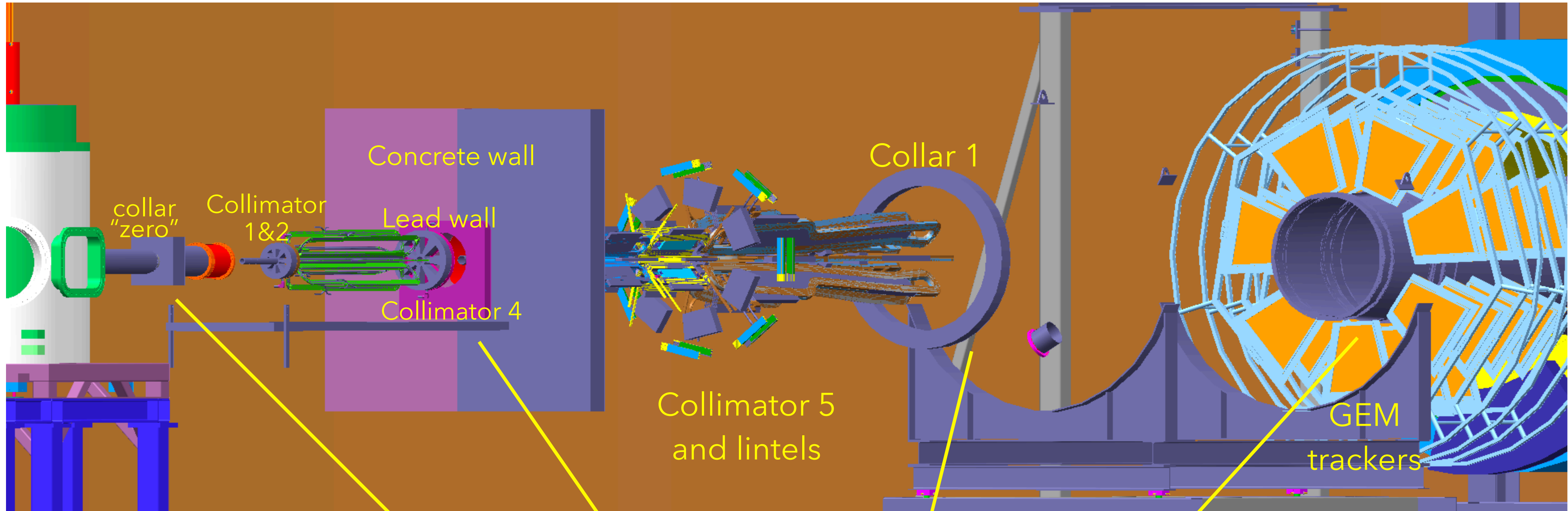

# More Detectors

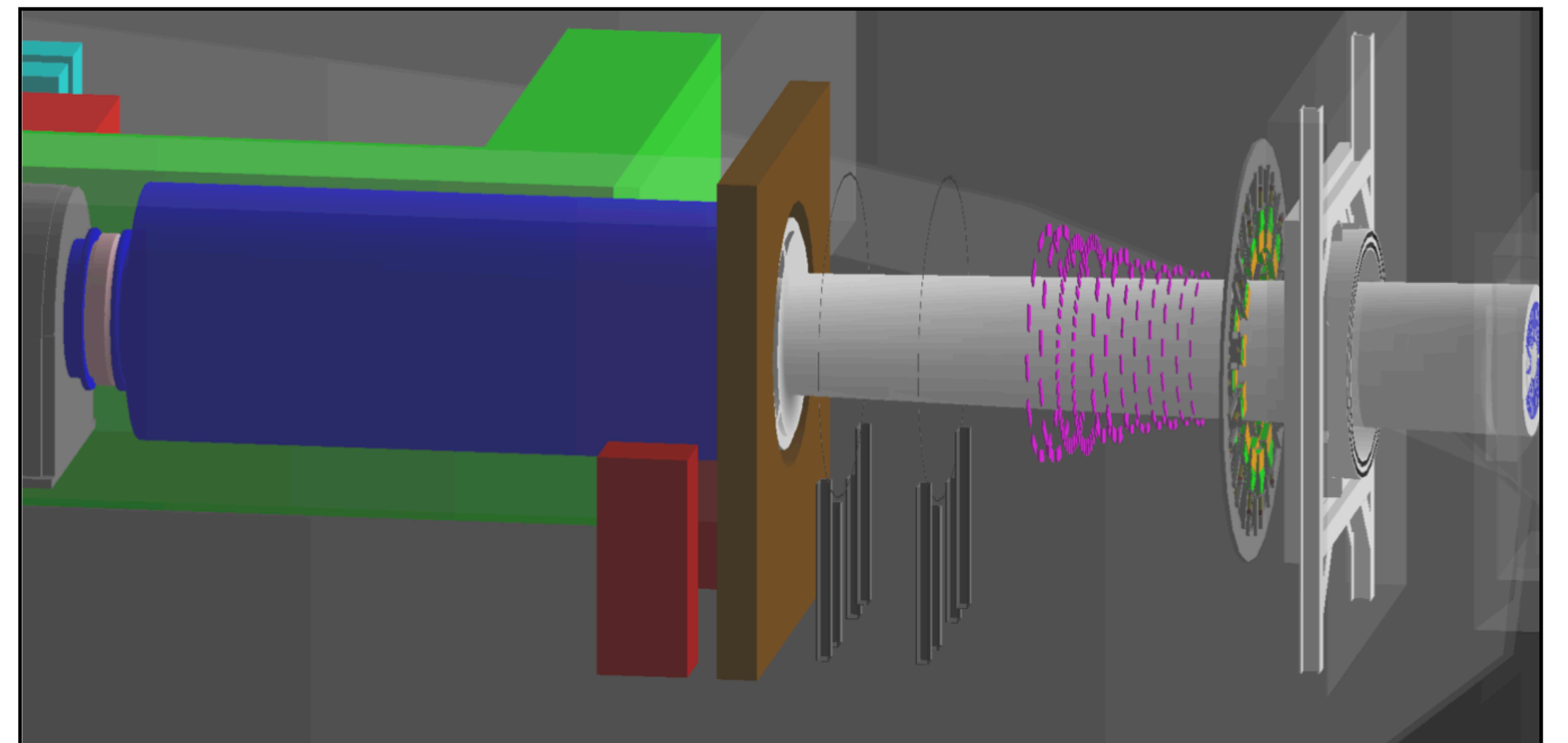
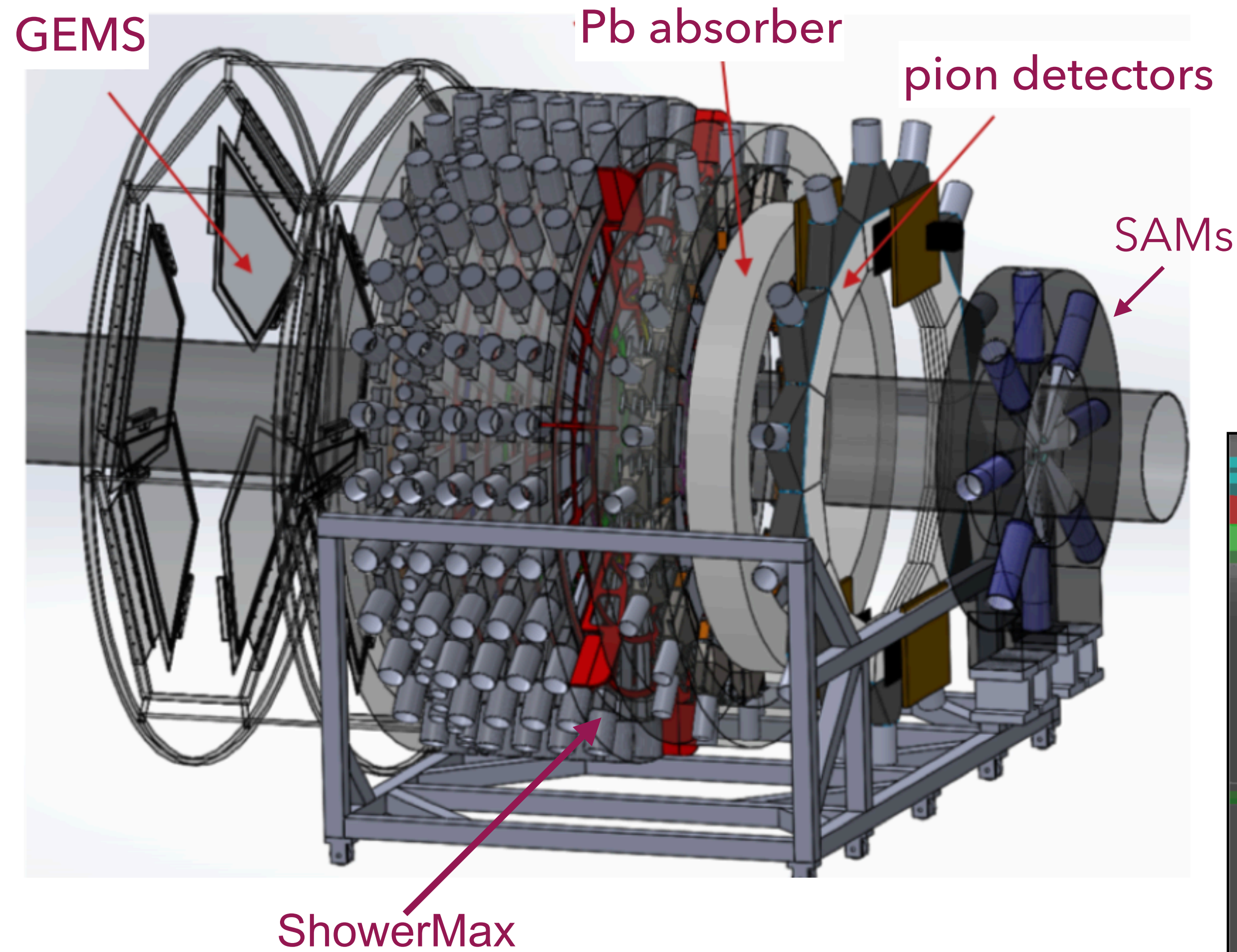



# Simulation Topics

Most everything we do falls in to one of these categories

- Radiation control for equipment (hall electronics) and personnel protection (boundary)
- Radiation estimates for radiation damage in apparatus (coils, o-rings)
- Rescattering for control of measurement in main detector (or other detectors)
  - Edges, field imperfections...
  - rare events (e.g. ferromagnetic materials)
- Maintain Spectrometer and Detector optimization through final engineering
- Physics extraction

This ~50M\$ project is taking off, and responding to engineering/design topics must remain our top priority

But we are also pivoting to figuring out the details of using this apparatus to measure  $A_{PV}$ , developing run and calibration plans, and writing analysis software

We're looking forward to having your help with this work!