

# Target region strategy and simulation results

Ciprian Gal for Tao, Zuhal, Zhongling



**Center for Frontiers  
in Nuclear Science**



**Stony Brook  
University**



**Jefferson Lab**

# Boundary dose impact

- We took a look at the same detectors (5555, 5556) over the 3 configurations
  - Look only at particles with  $E > 10\text{MeV}$
- Also evaluated rates at the roof of the hall
- For this analysis we also need to evaluate if dropping the roof by 60 inches would see a significant increase in the boundary dose

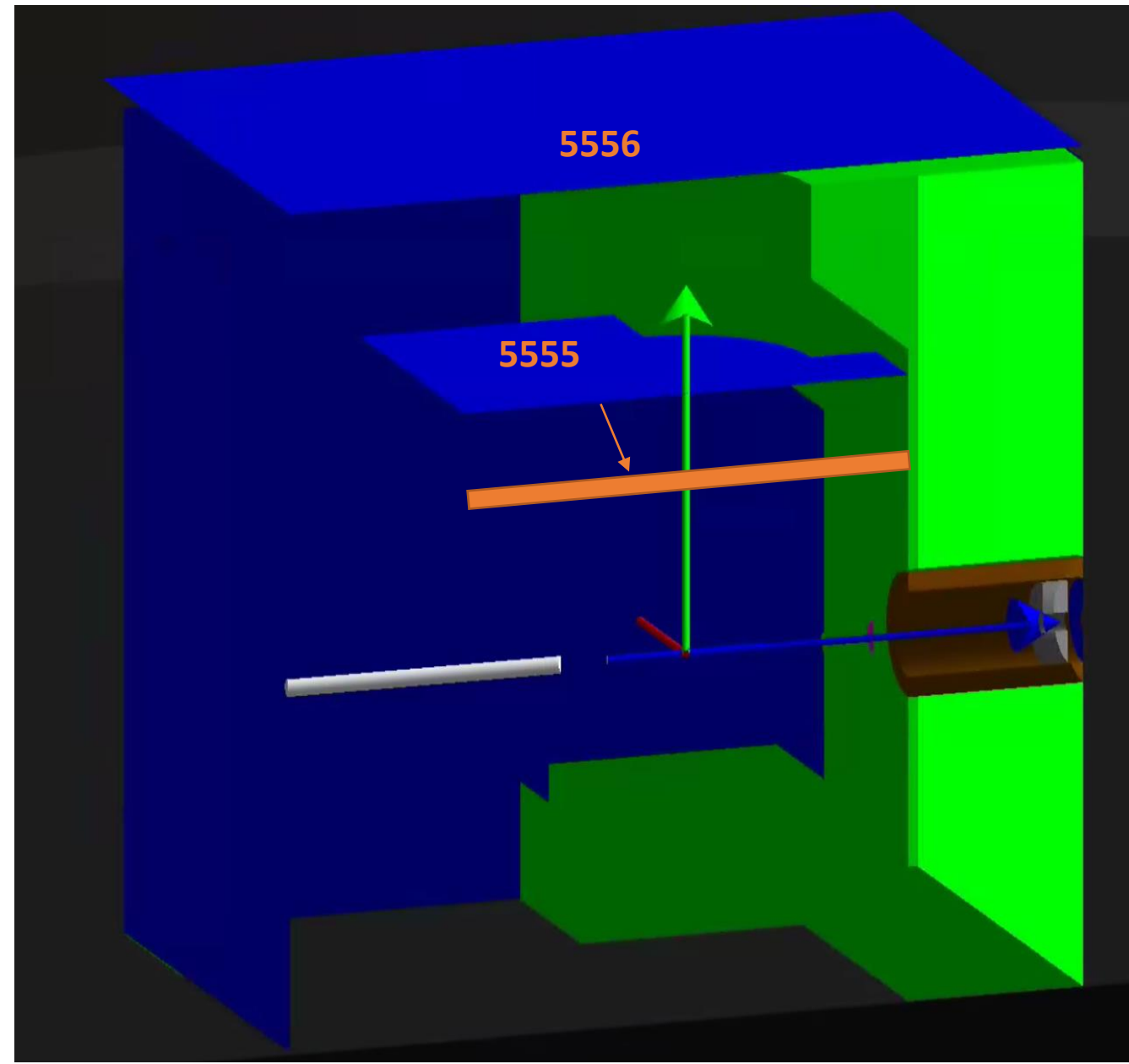

# Old summary

- Can we have a 2m hole through the shielding on the top of the target?

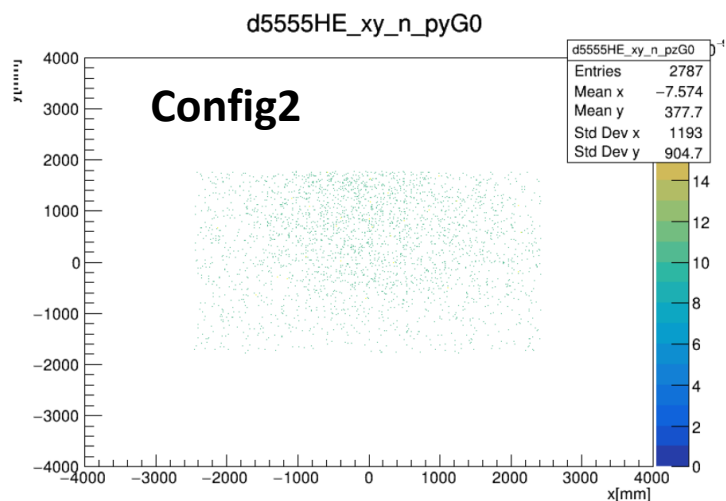

Full bunker

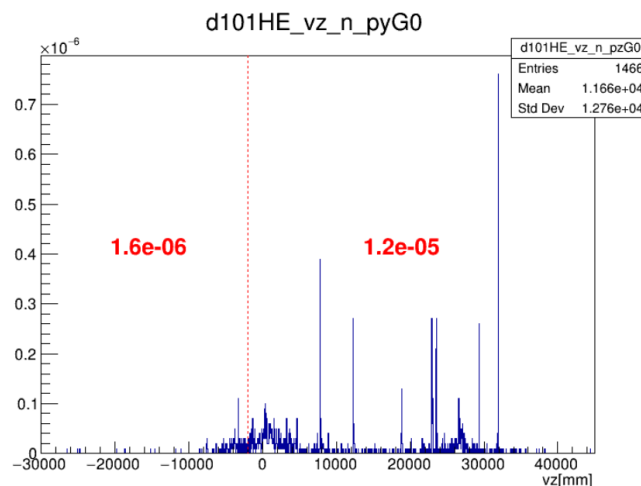

Config2:

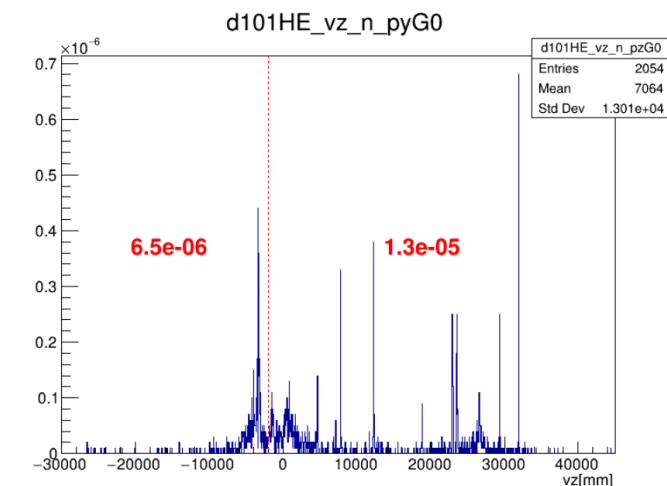

- While we see an increase of about factor 4 from the target the overall increase is only 1.4 times
- The DS half of the hole allows about a factor of 2 more HE neutrons to pass than the US half
  - If possible we should cover the DS half

type	old				
	hole us (%)	hole ds (%)	d5555	d5556	survive (%)
em	4.22	14.44	4.11E-05	5.00E-08	0.12
g	9.49	18.43	9.97E-05	5.60E-07	0.56
n	11.44	18.60	3.67E-05	1.07E-06	2.91
ep	9.72	20.13	3.98E-05	4.00E-08	0.10

# Boundary dose:

neutron (E > 30MeV) Integrals			
detID	Conf 1	Conf 2	Conf 3
5555	2.29E-05	1.97E-05	1.53E-05
5556	9.80E-07	3.53E-06	5.56E-06
neutron (E > 10MeV) Integrals			
detID	Conf 1	Conf 2	Conf 3
5555	4.02E-05	3.04E-05	2.65E-05
5556	1.07E-06	4.88E-06	8.78E-06
101(roof)	1.53E-05	2.15E-05	3.27E-05
increase at roof	100%	141%	214%

- We can see that the increase with configuration 3 is significant
  - We estimated 2.4mrem/year with conf1
  - The increase is visible in the backward direction on the roof detector
- Conf3 actually seems to provide a decrease inside the bunker (look at the 5555 numbers) compared to conf2

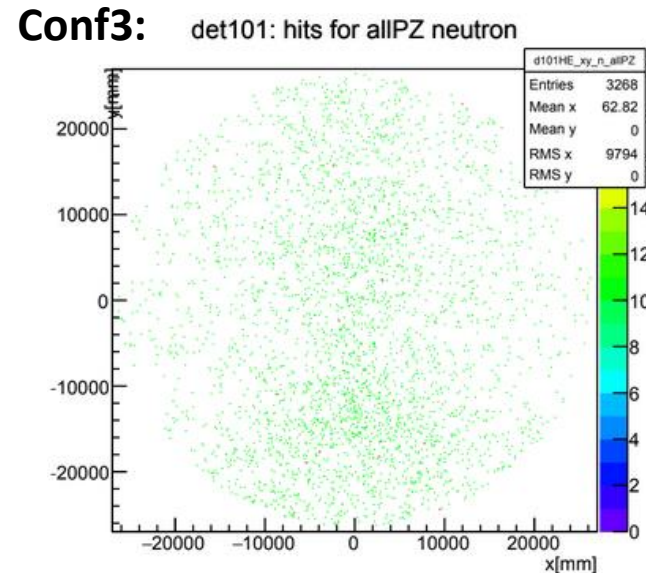
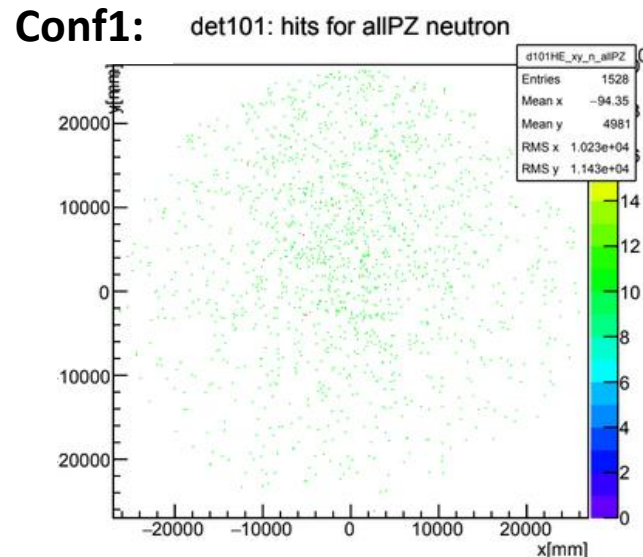



# Boundary dose source

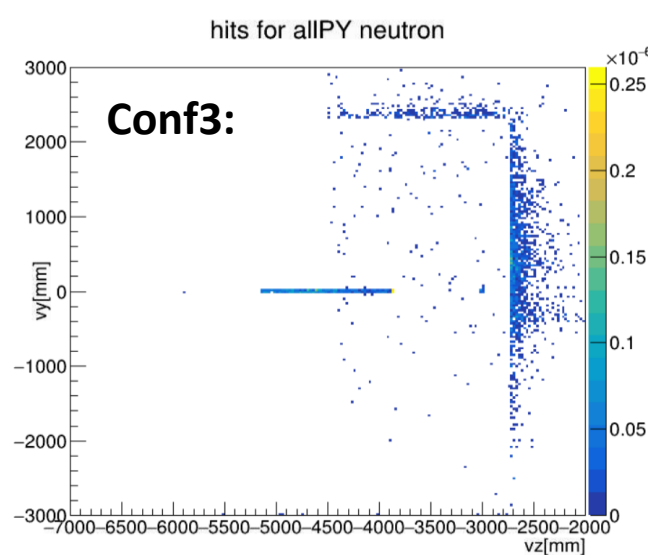
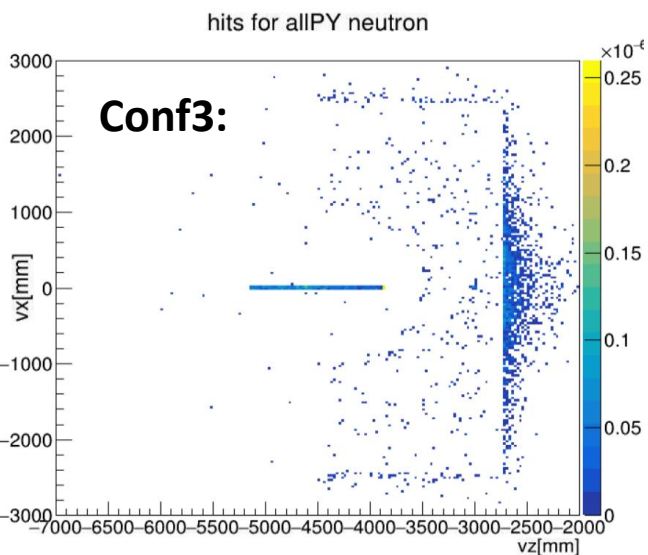
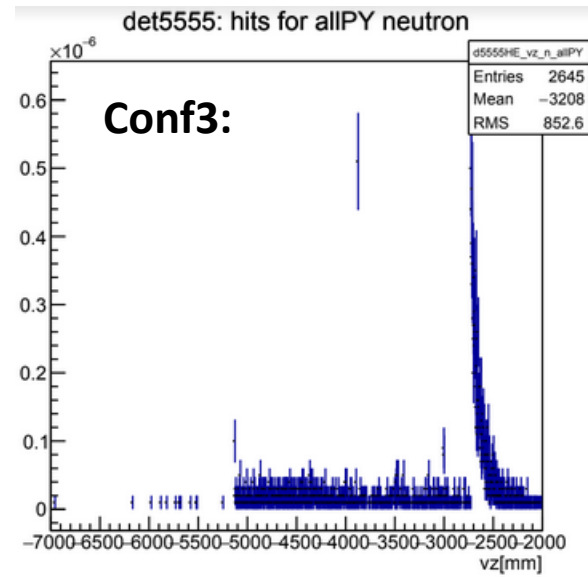
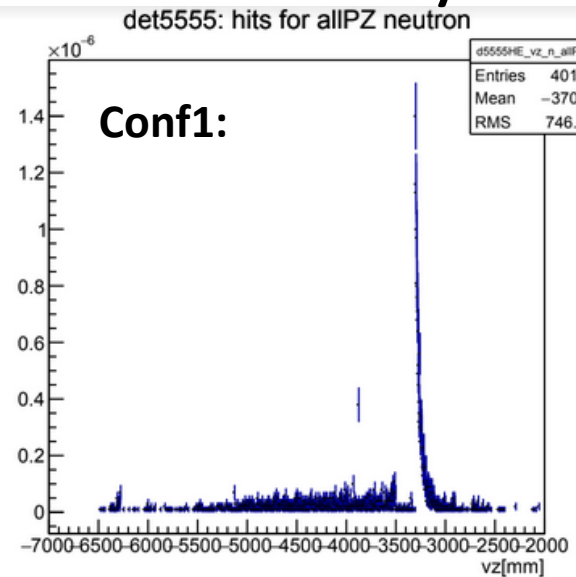

- Between conf1 and 3 the source of the high energy neutrons inside the target moved back
  - Conf1 source was the Pb wall
  - Conf3 source seems to be the downstream wall of the bunker
- Specifically it seems to come from the barite region (although the material doesn't matter)
  - One option is to recess the barite further inside the regular concrete wall so that we can have a significant amount of concrete directly above the region
  - This would need to confirm that everything will remain safe DS (remember the issue from last week)

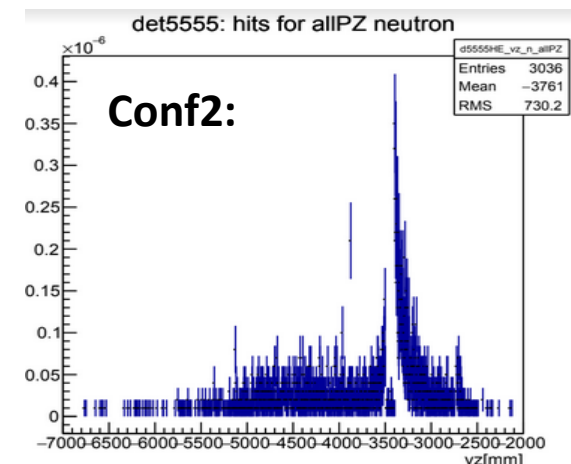

# Config3-> projection 60in below

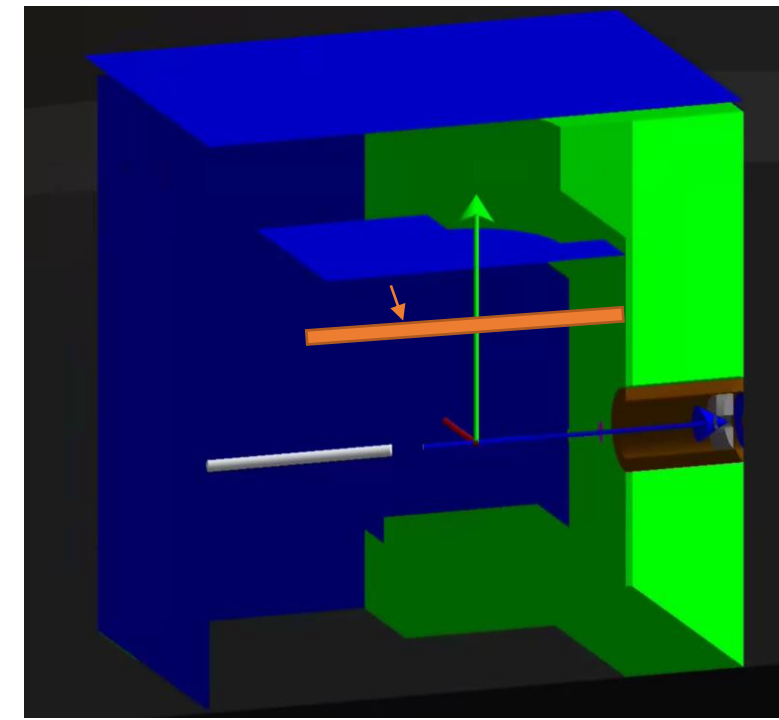
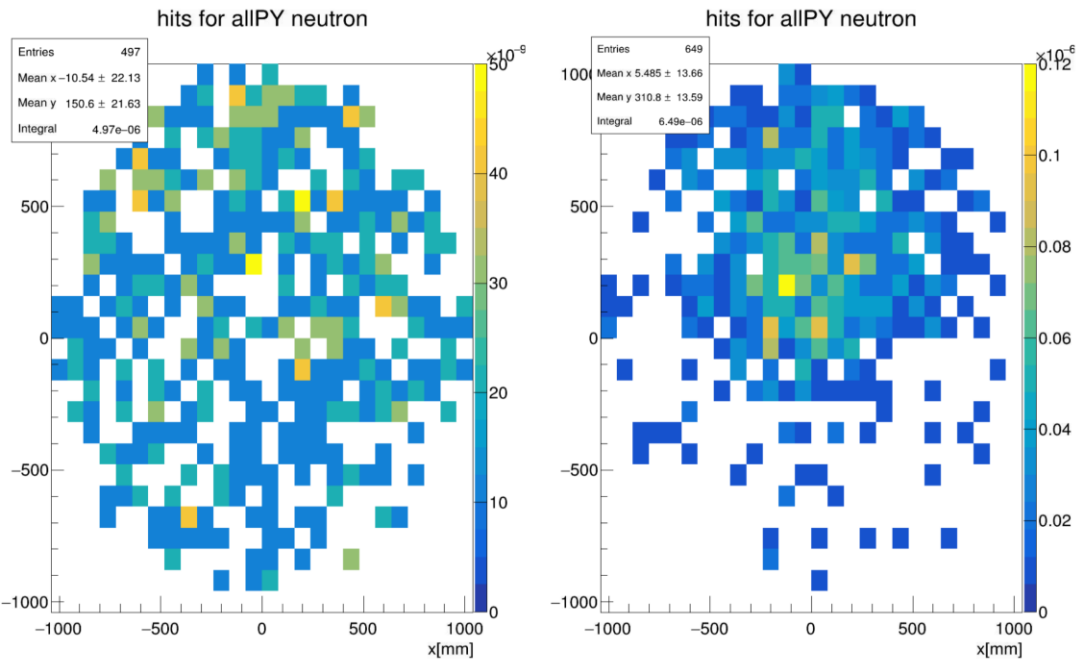

- We see a 30% increase in the number of HE ( $E > 10\text{MeV}$ ) neutrons in the 2m hole if we lower it by 60in
  - The distribution is more forward peaked as well
  - This is just a rough estimate; a full analysis will come once we implement the geometry
  - This 30% increase from the target would get us to  $\sim 1.7$  times the boundary dose ( $2.4 \rightarrow 4.0$ ) most of which would come through the DS half of the hole
- A full configuration will need to be made with an actual lowered skyshine shield since we could probably mitigate this increase

# Conclusions and Next steps

- Front of SBS bunker does see an increase but the spectrum seems fairly soft
  - No increase expected inside the bunker
  - Meaning that the sides of the bunker are not 100% necessary (if it helps with engineering)
- Conf3 showed some interesting issues inside the bunker for high energy particles
- Conf4 will be designed soon with the following features:
  - Increase the barite area and reach down to 11in around the beamline
  - Recess the barite region
  - Put back the upstream side of the skyshine shield
  - Lower the skyshine by 60 inches
- We need to evaluate the thickness requirements for the roof and the sides
- We should configure the beam right electronics region

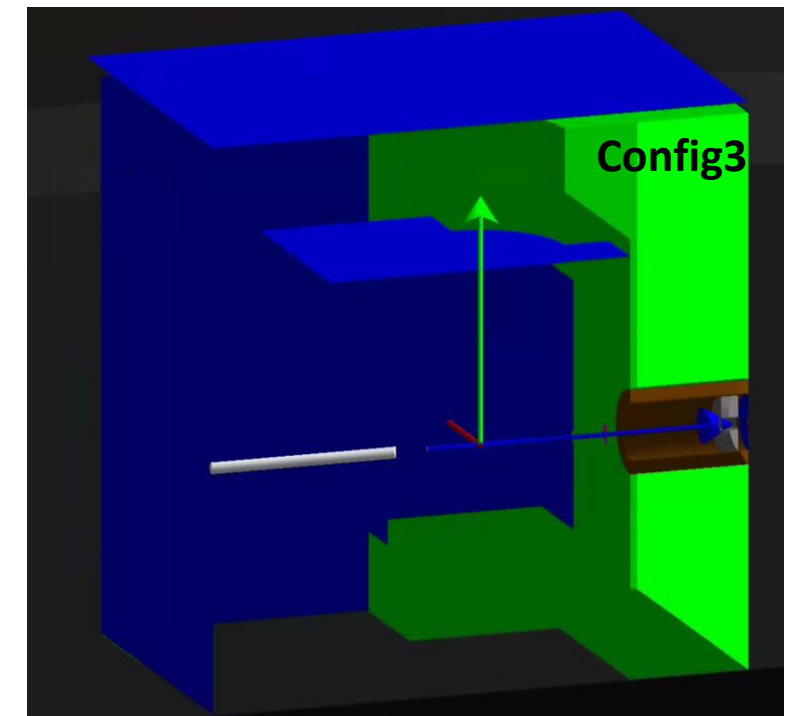
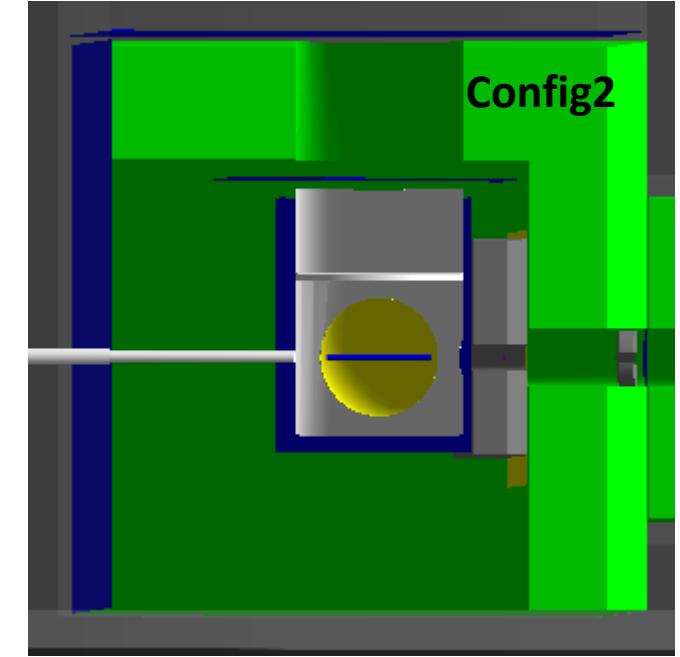

Feb2:

# Modifications made around target

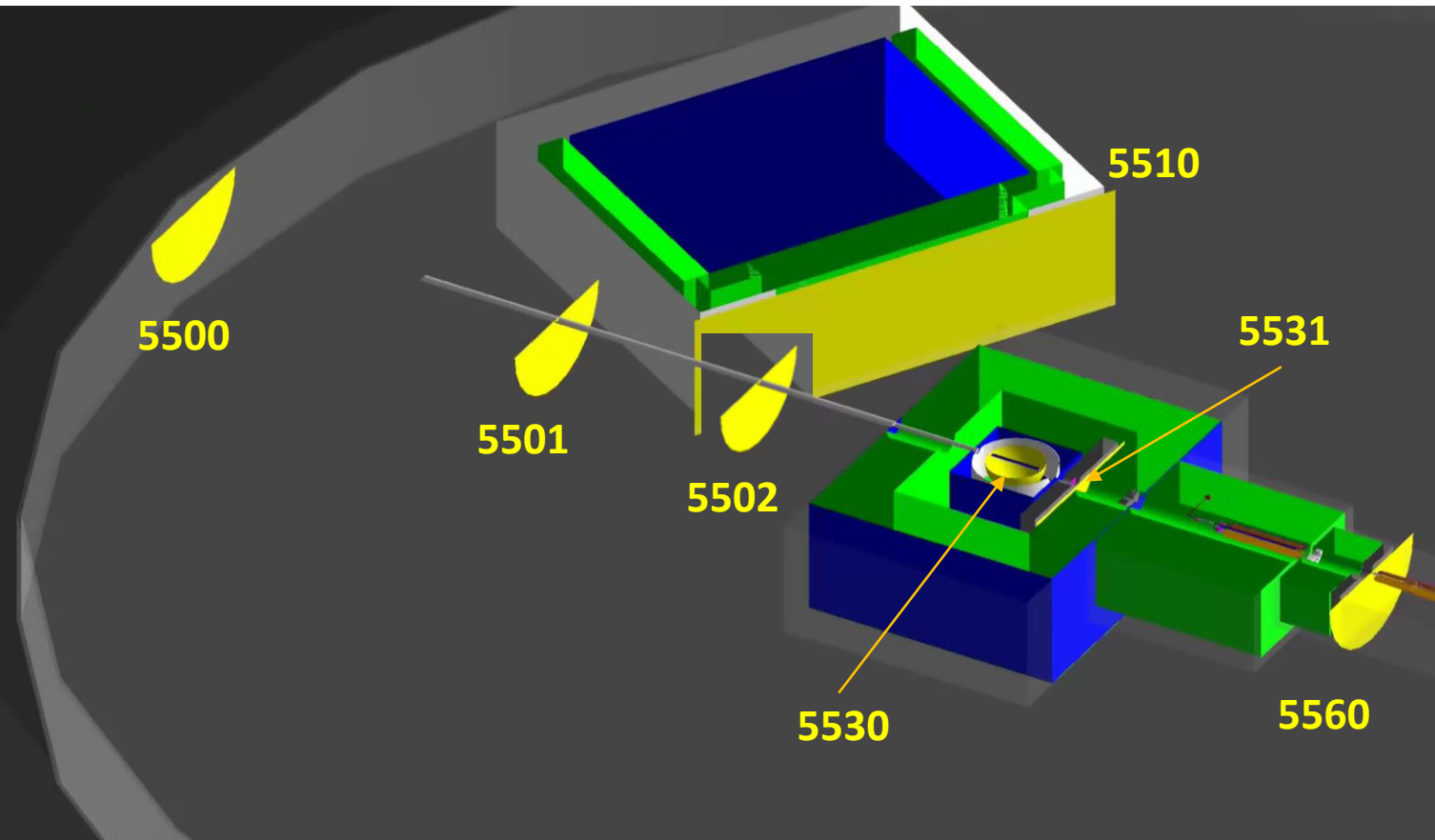

- Left all previous detectors alone
  - The hope is to remove them at some point later
- Added:
  - sphere detector around target
  - Plane DS of the target lead wall
  - Plane DS of US toroid (should be made kryptonite)
  - Plane US of the sbs bunker
  - Plane around moller and entrance of the hall (named Compton)
  - Plane detector at the moller polarimeter detector location
  - Use US outside shielding detector to evaluate harp/BPM radiation

# Updated geometry: Config2

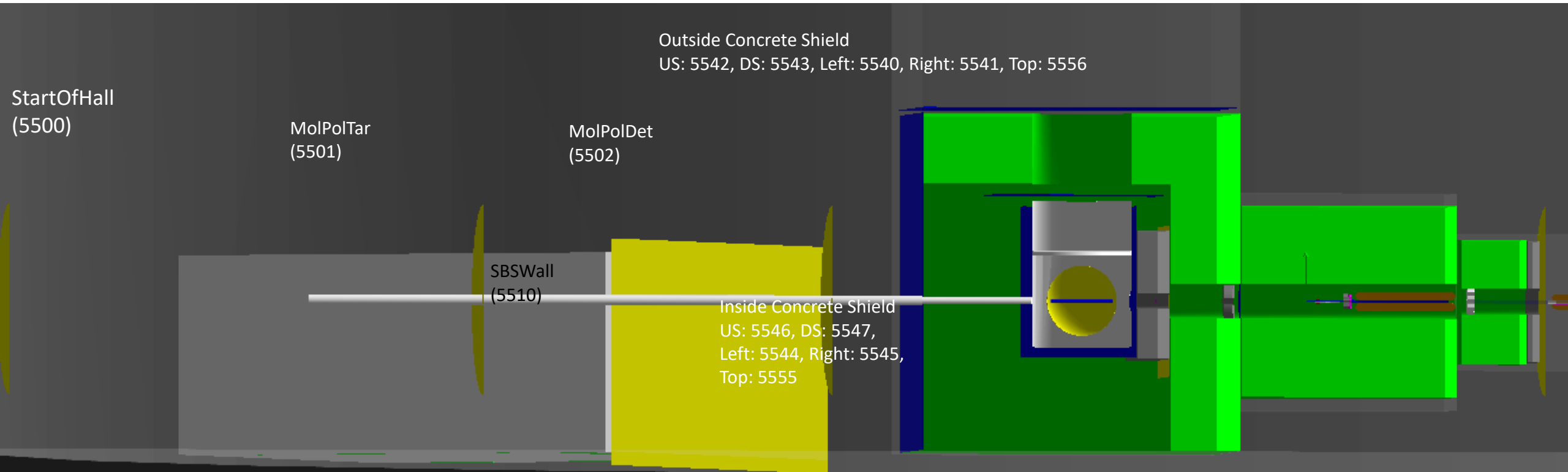

- Geometry updated by Sakib with replacement of the material of the Pb wall to concrete and increase from 40cm to 65cm (maximum)
- Remove upstream wall
- 2m hole on the room



# Extended change (Config3)

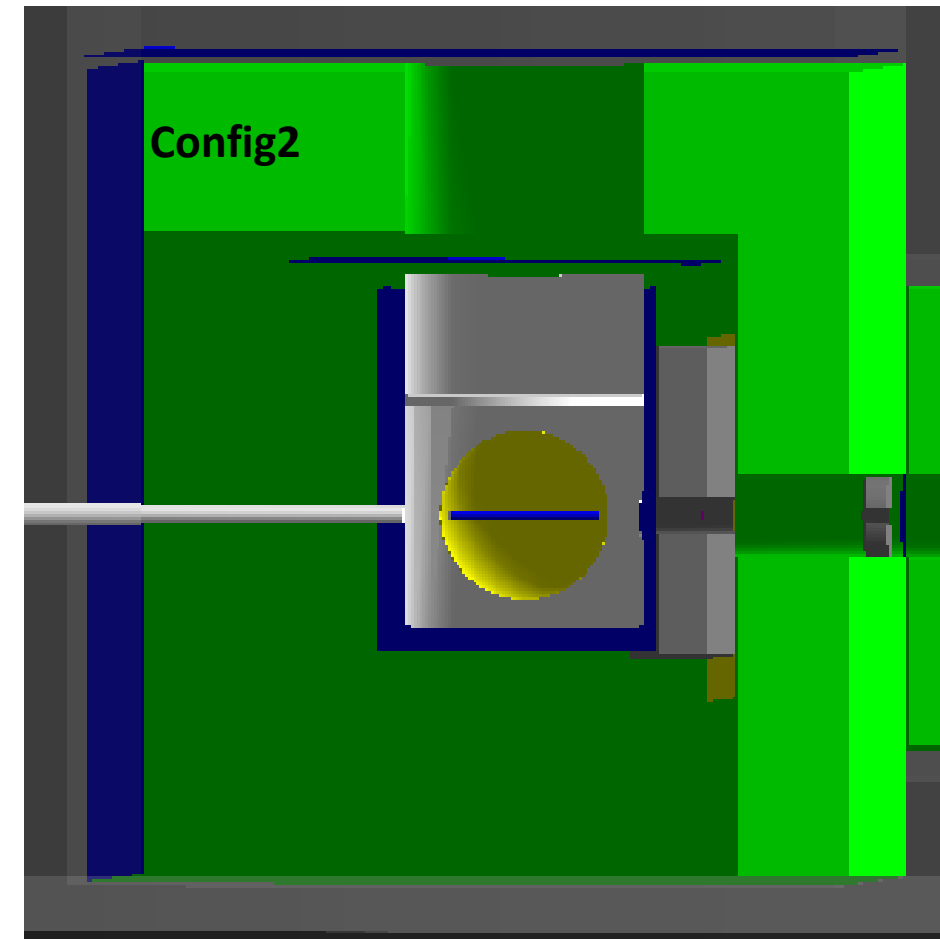
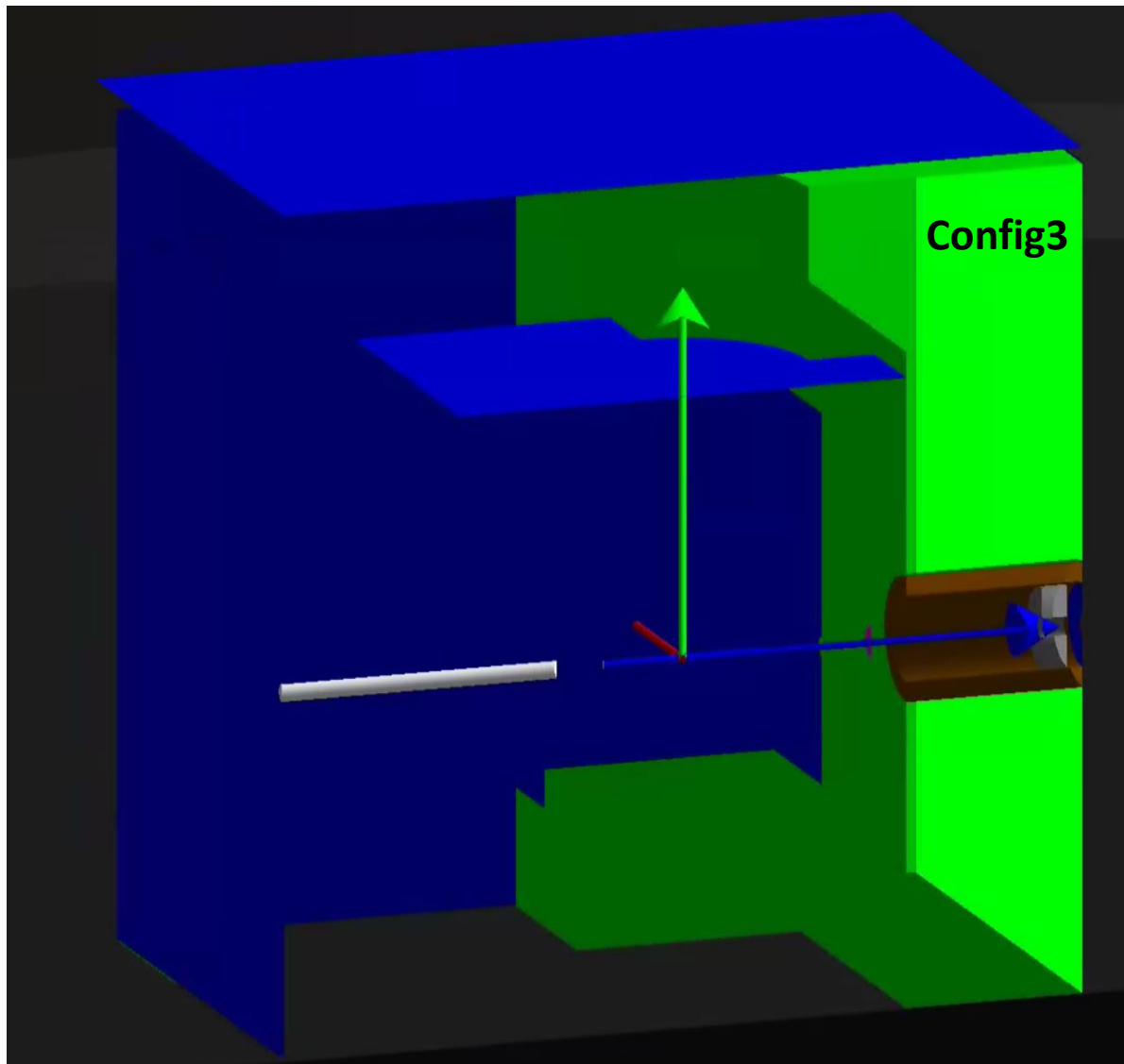

- Decided to take a look at a configuration that doesn't have any shielding US of the center of the target
- The (brown) inner bore of the DS concrete is barite (36-50.5 cm)
- While this may turn out unrealistic I figured it would be instructive
  - SBS bunker analysis pending

# MD output from V1-V2 configurations

Fit	uncert
1.0004	0.0052
0.9988	0.0052
0.9936	0.0016
1.0162	0.0146
1.0047	0.0079
0.9693	0.0170

**Black:** gamma  
**Red:** e- and pi-  
**Green:** e+ and pi+  
**Blue:** neutrons  
**Magenta:** "e+/-" E>1MeV  
**Cyan:** primary E>1MeV

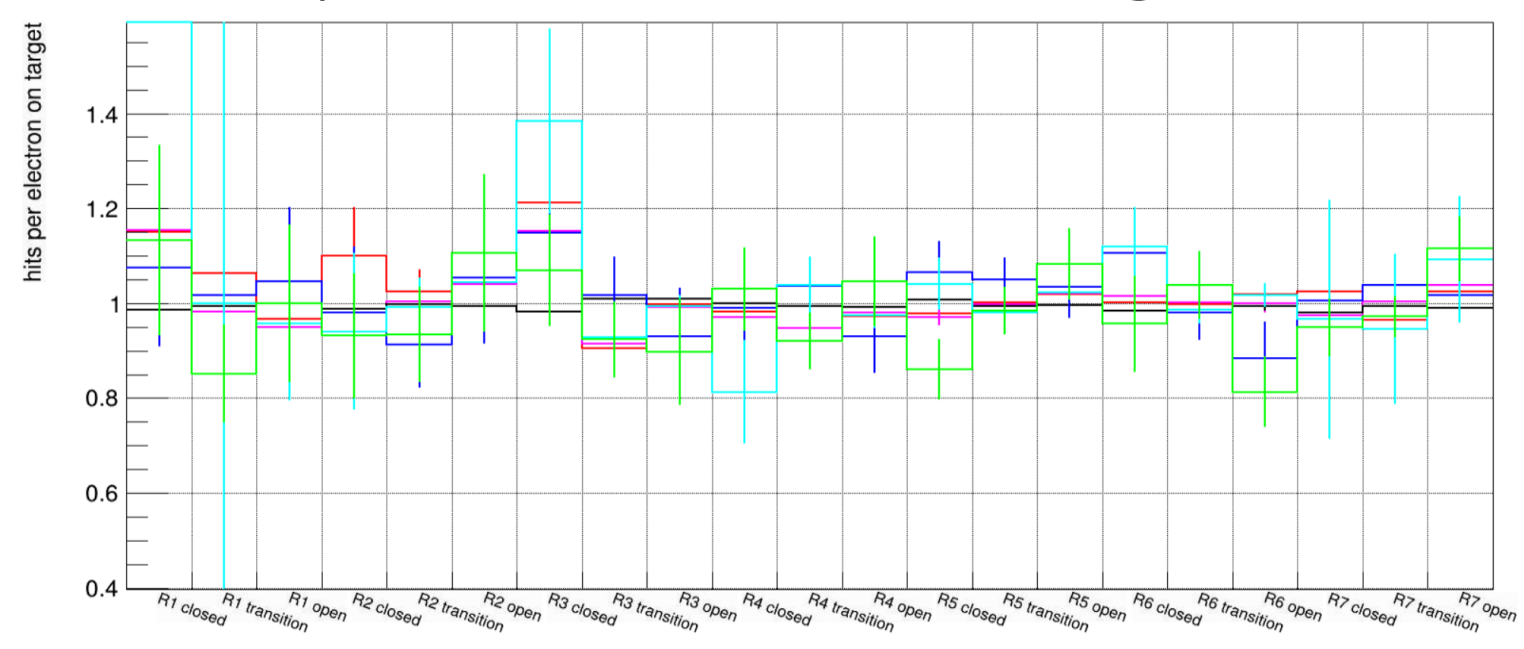

- The ratio of rates at the MD doesn't show any significant discrepancies
- PoI0 fit results show no difference

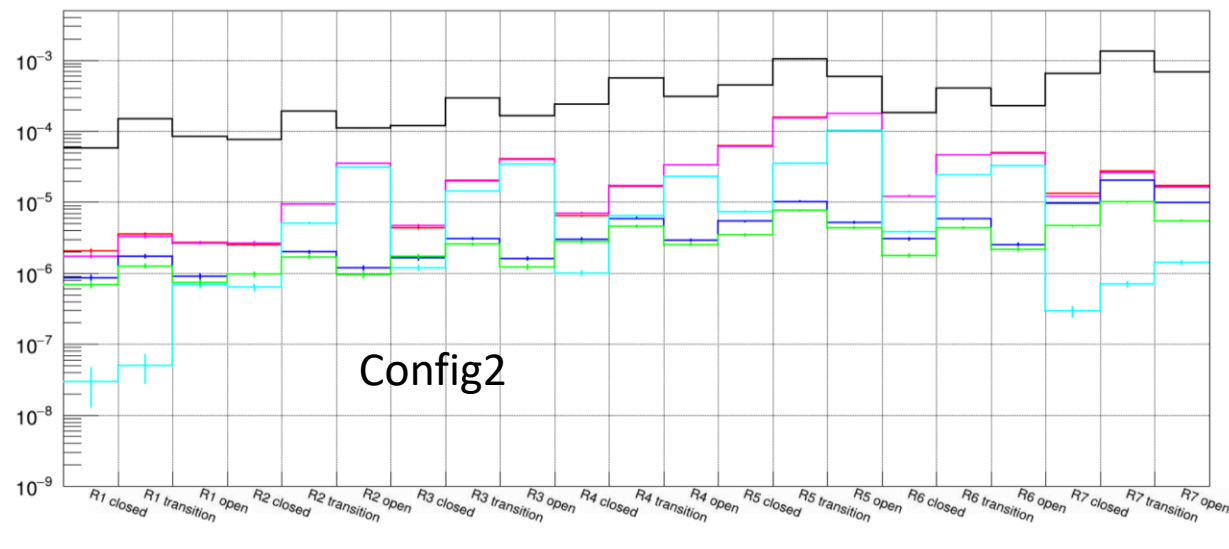
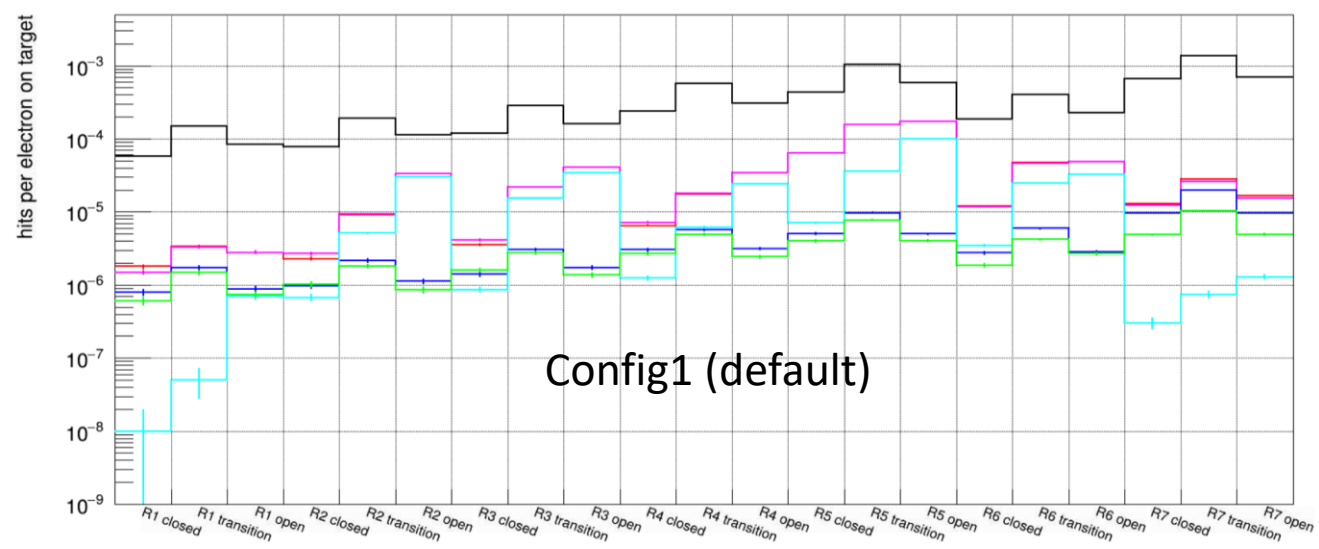

# MD output from V1-V3 configurations

**Black:** gamma  
**Red:** e- and pi-  
**Green:** e+ and pi+  
**Blue:** neutrons  
**Magenta:** "e+/-" E>1MeV  
**Cyan:** primary E>1MeV

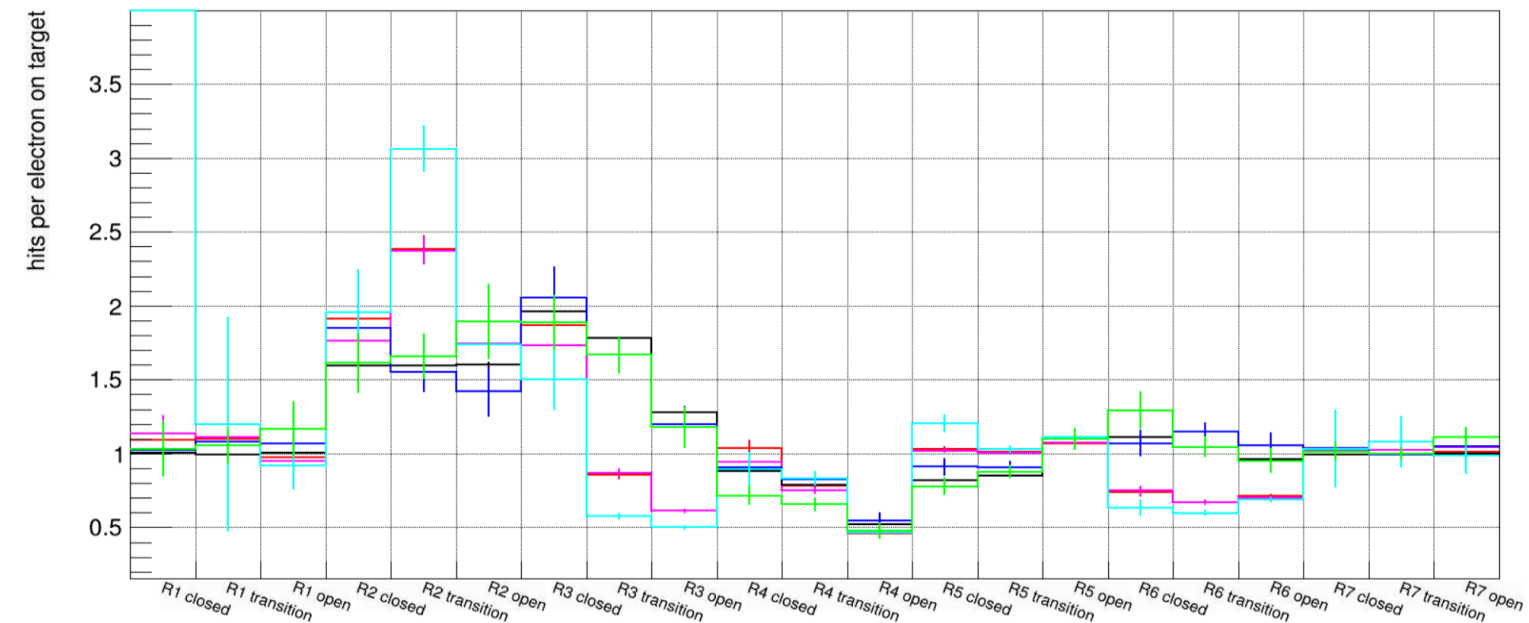

- The ratio of rates at the MD doesn't show any significant discrepancies in R5 but shows around a factor of 2 increase in all species for R2-3
- Change is probably related to the effective inner radius change

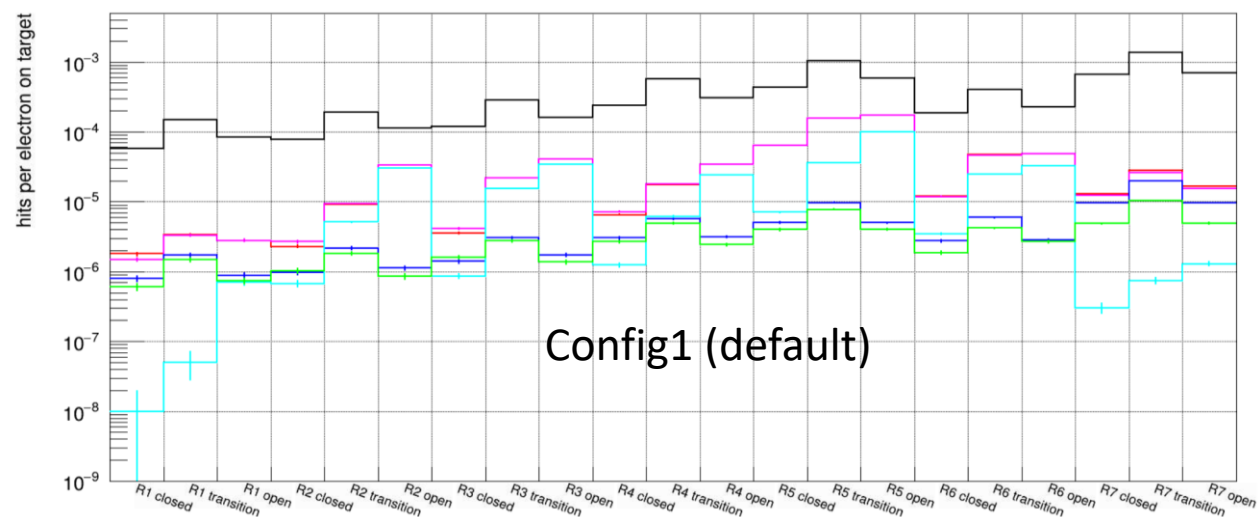

Config1 (default)

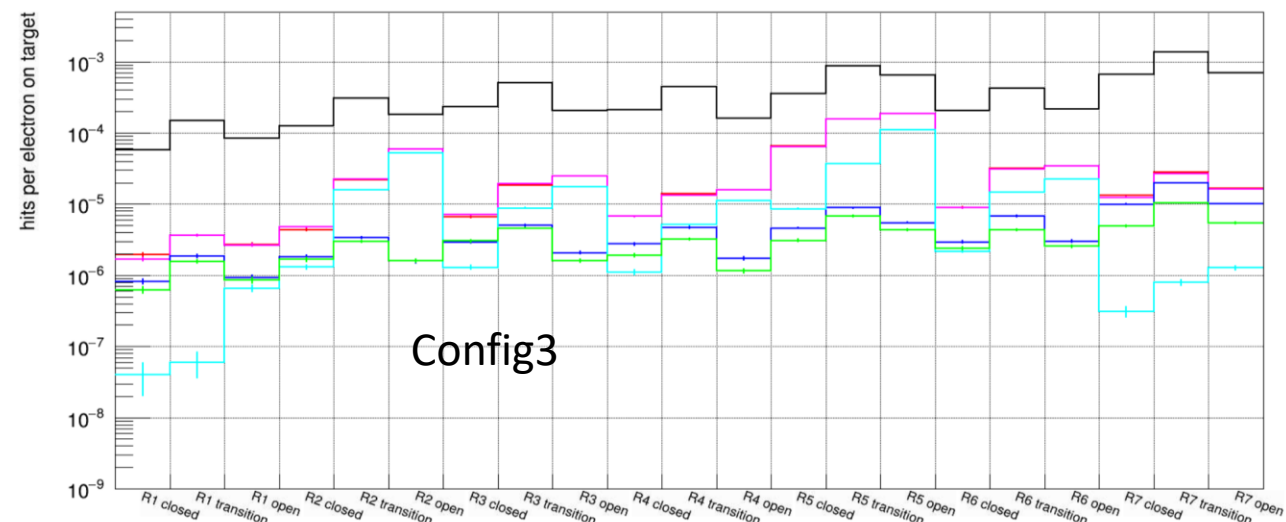

Config3

# MD output from 2 configurations

Fit	uncert
1.0004	0.0052
0.9988	0.0052
0.9936	0.0016
1.0162	0.0146
1.0047	0.0079
0.9693	0.0170

**Black:** gamma  
**Red:** e- and pi-  
**Green:** e+ and pi+  
**Blue:** neutrons  
**Magenta:** "e+/-" E>1MeV  
**Cyan:** primary E>1MeV

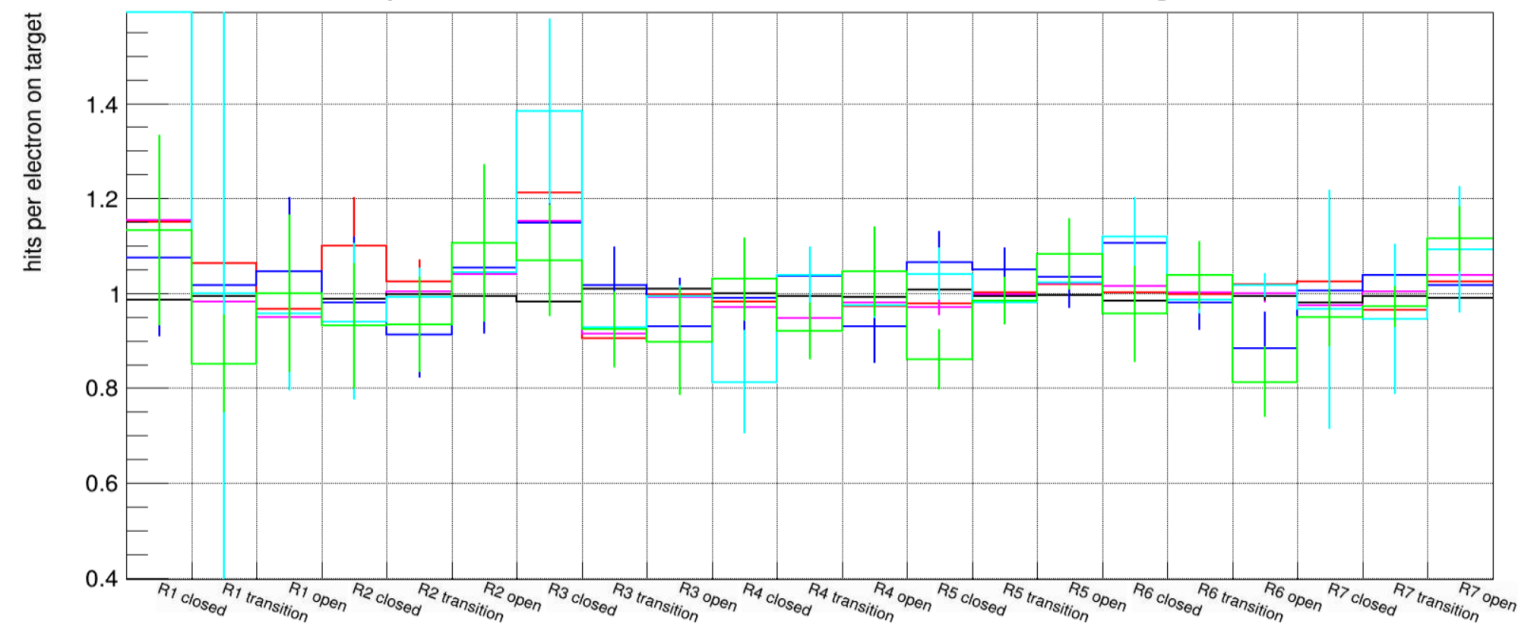

- The ratio of rates at the MD doesn't show any significant discrepancies
- PoI0 fit results show no difference

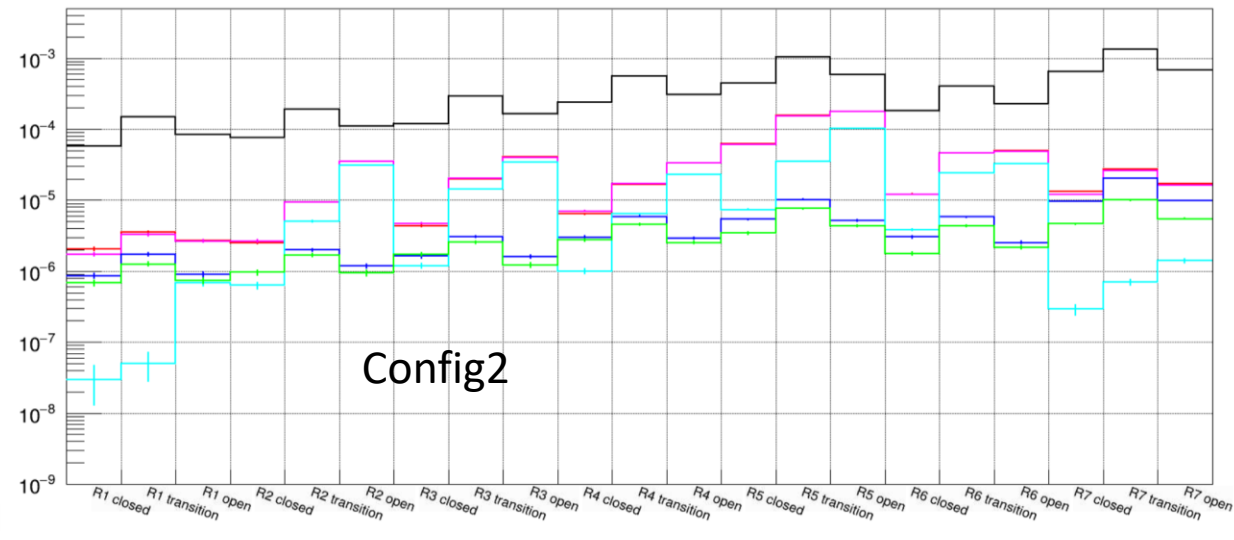
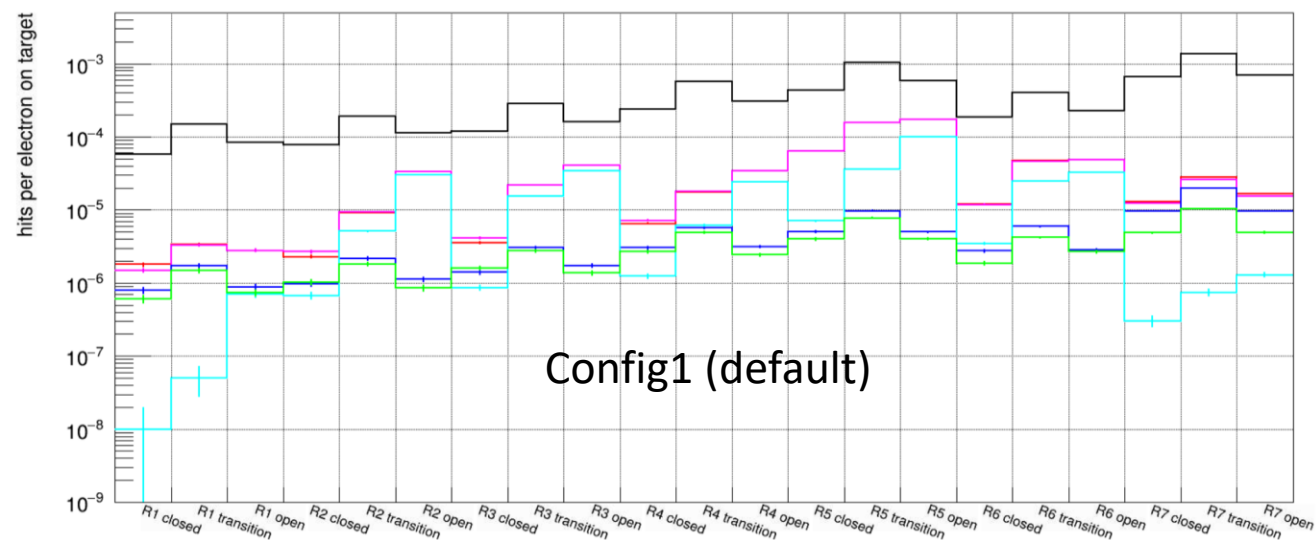

# US electronics definitions

1. Compton: entire 1.9m disk at entrance to hall ( $z=-26\text{m}$ )
2. Moller polarimeter tgt:  $R<20\text{cm}$  at  $z = -16.5\text{m}$
3. Moller polarimeter det:  $(X,Y) = (0,0)-(10,20)\text{cm}$ ; 20cm wide 30cm tall; at  $z = -9.5\text{m}$
4. Beamline US of target: flat detector  $z = -7.7\text{m}$ 
  1. Beamline elements:  $7<R<10\text{ cm}$  outside beampipe
  2. Electronics: 1m below beamline, 1x1m plane

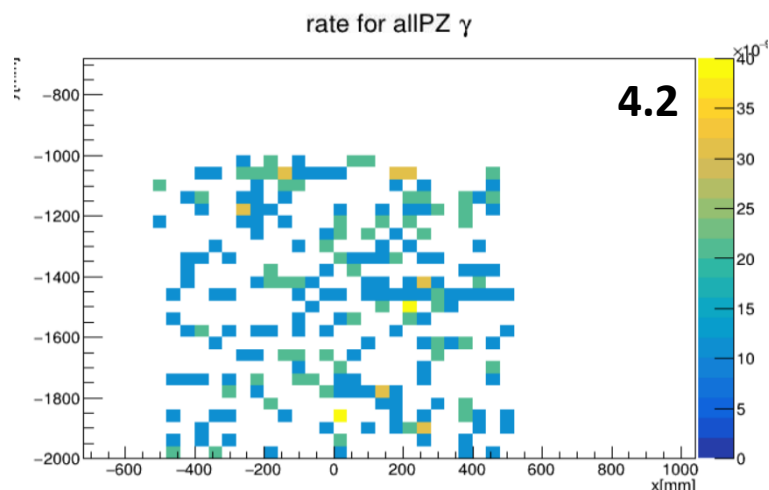
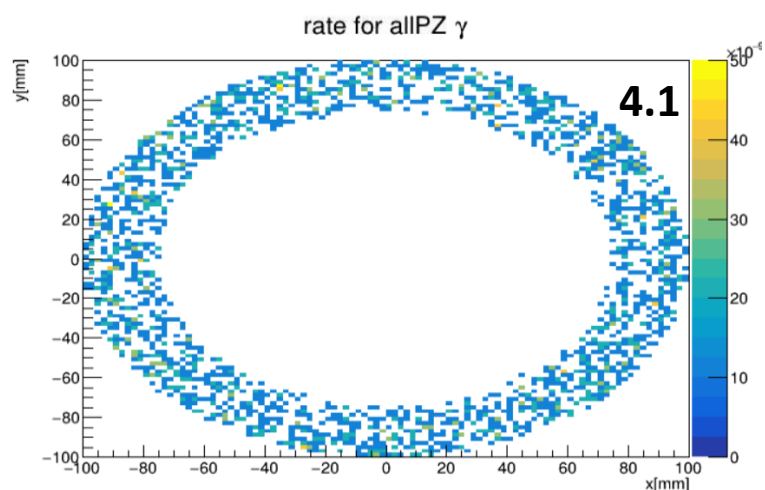
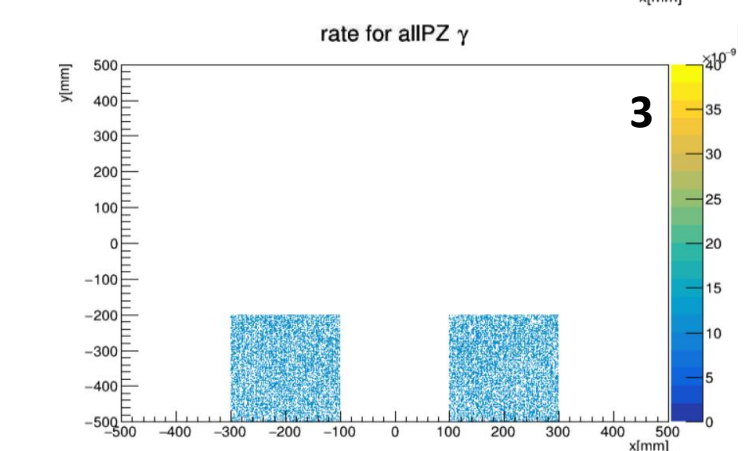
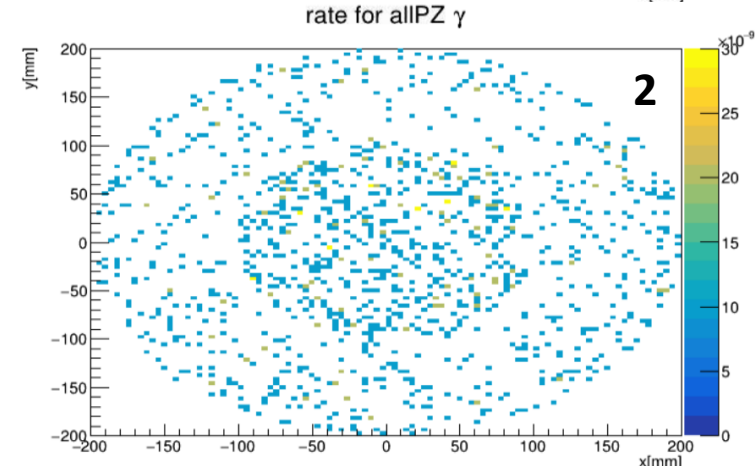
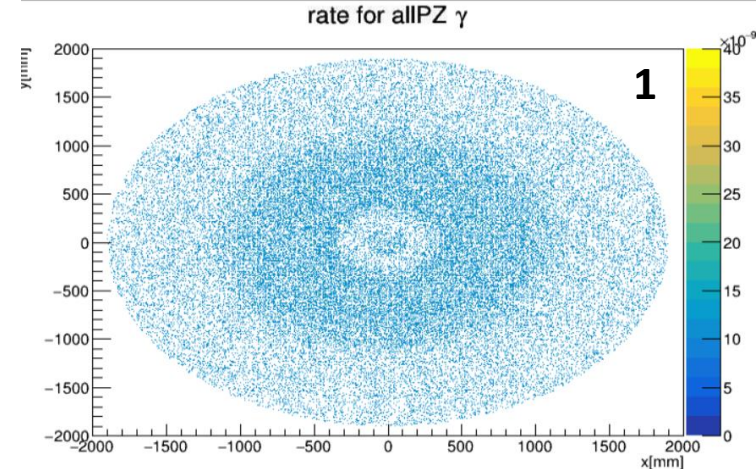



# Compton distributions:

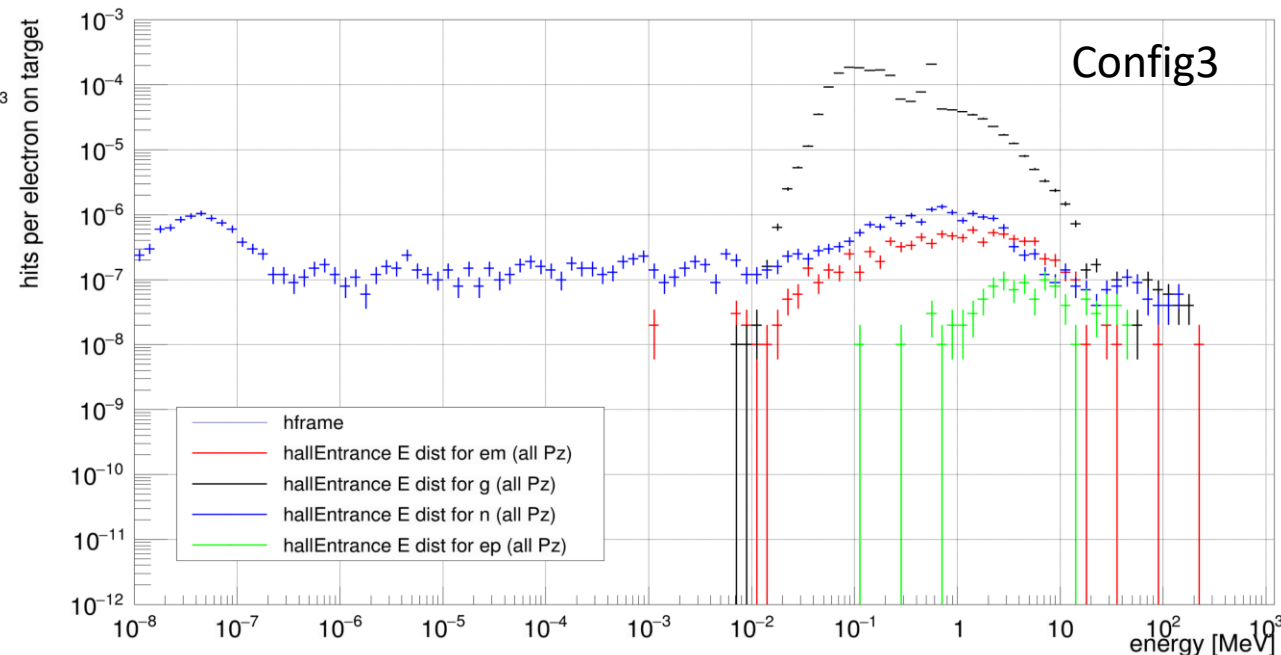
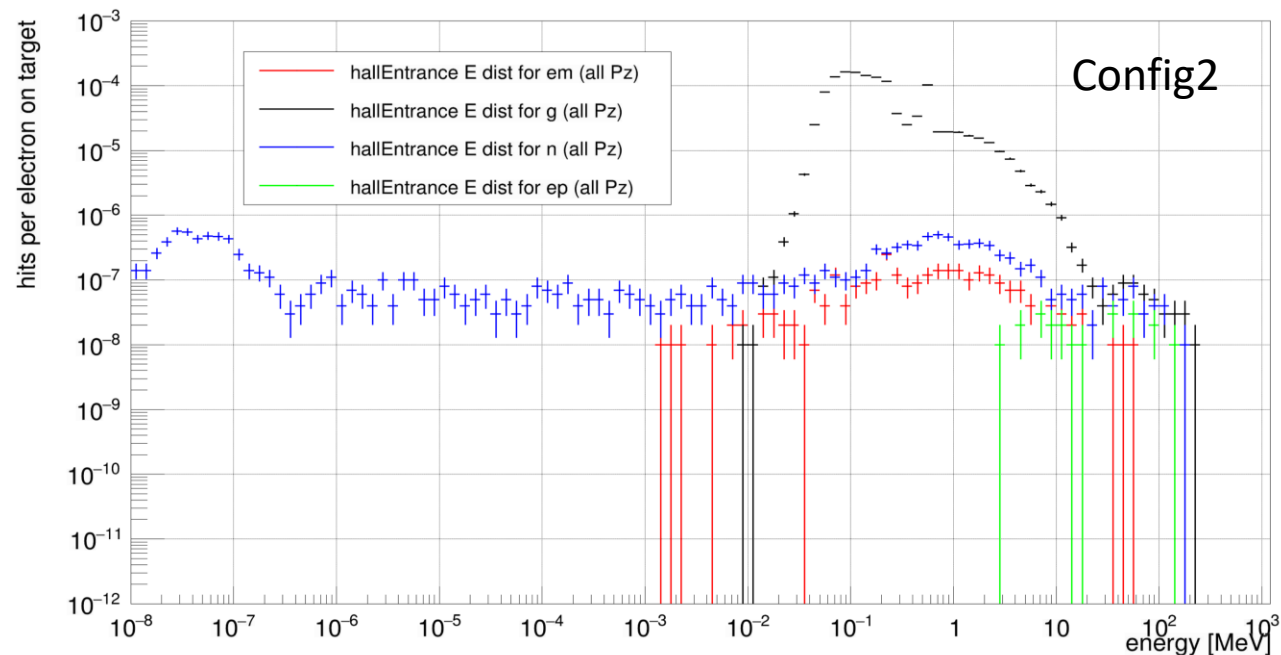
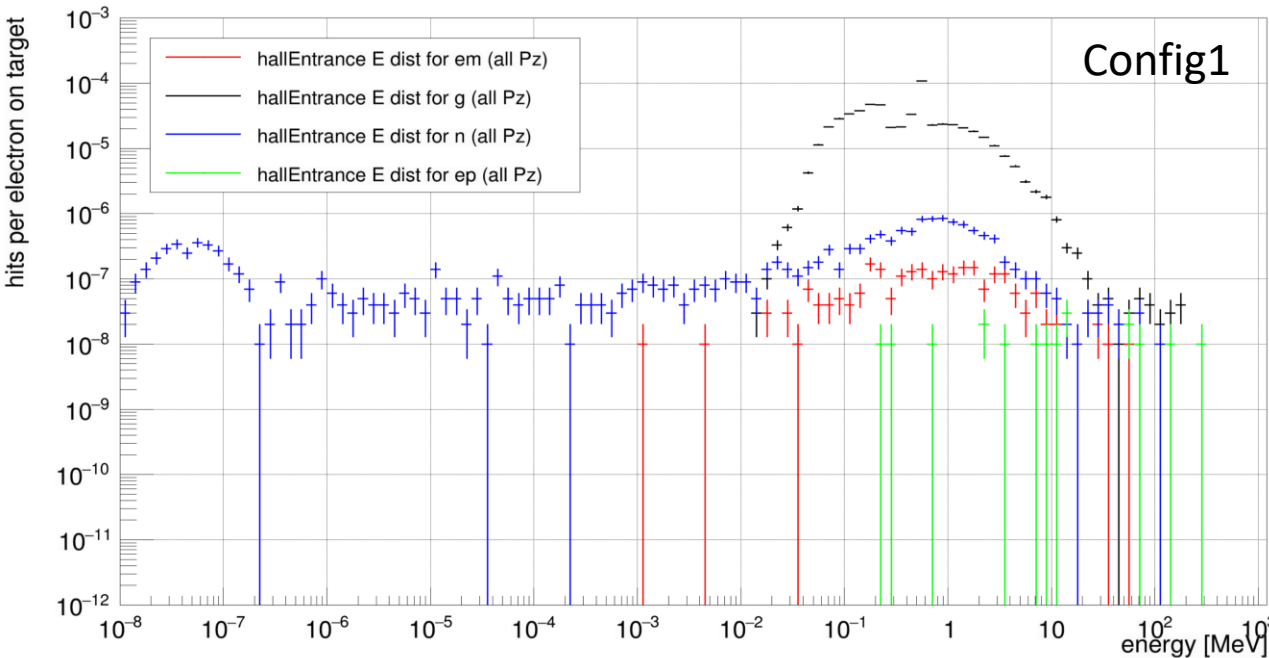

- Opening up the US wall does produce an increase in radiation at the entrance of the hall by a factor of 2 for photons and neutrons
  - The neutrons are significantly softer due to the removal of the Pb
- Removing the additional “concrete-Pb” wall further increases the neutrons
  - This may be due to the “lack of shielding” for the Pb plug



# Beamline Moller polarimeter target

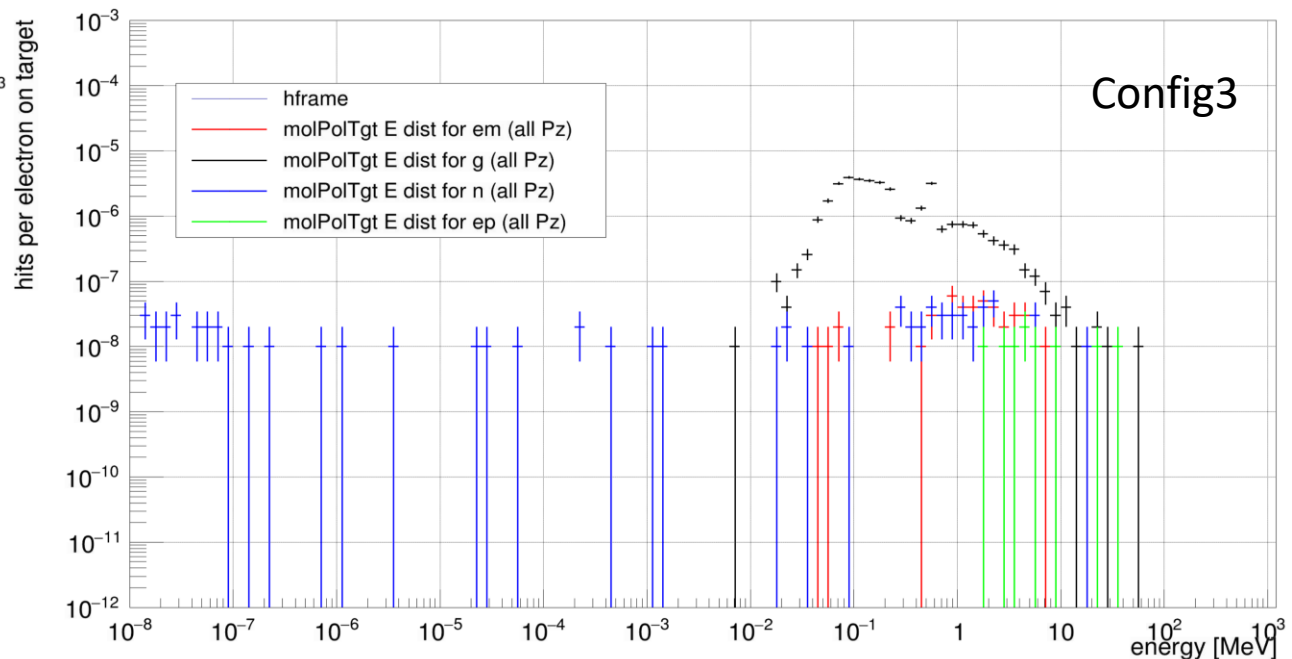
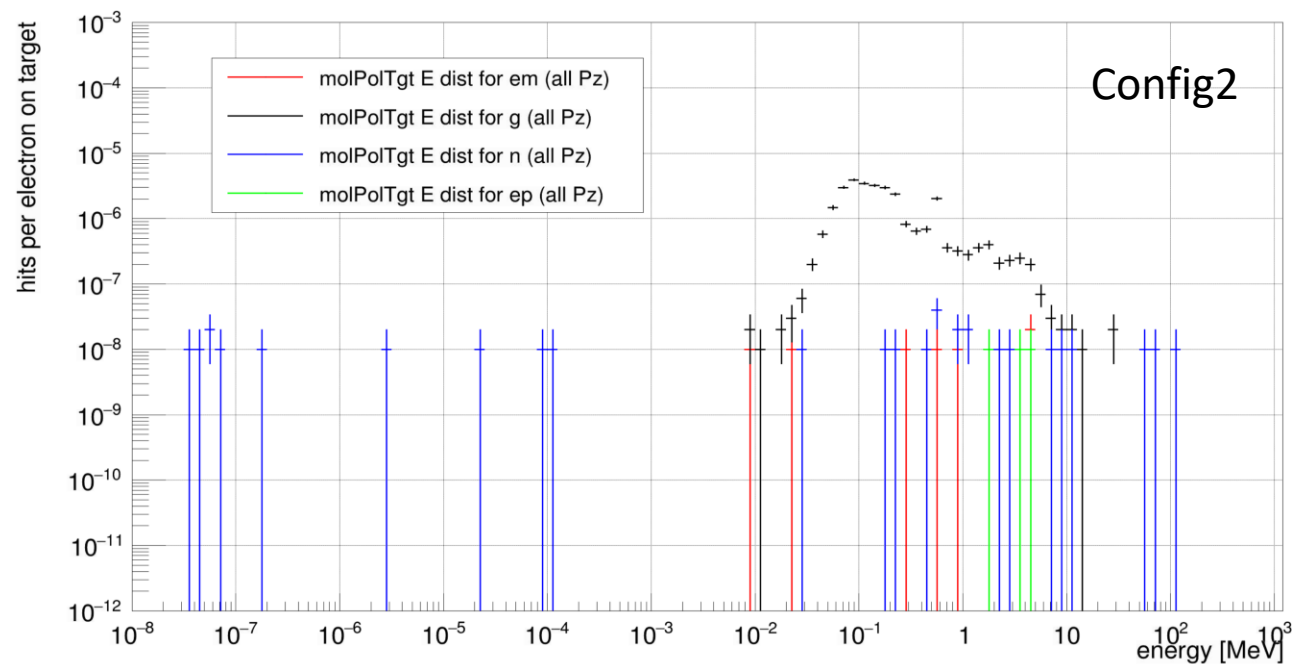
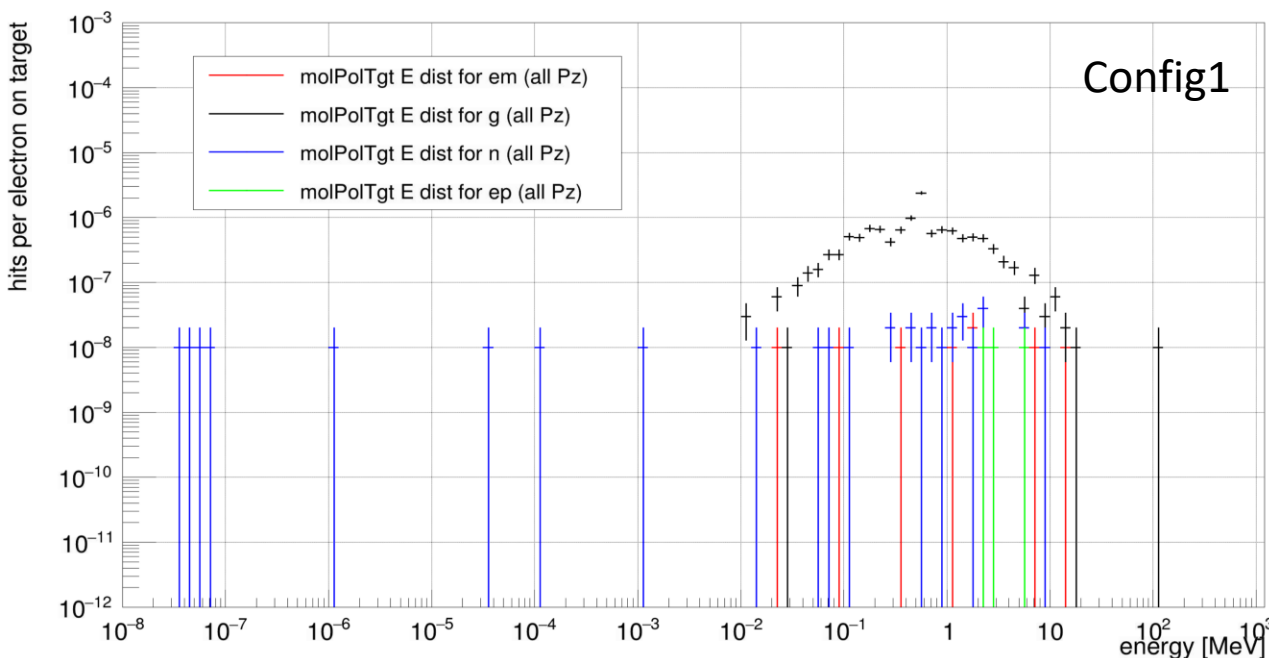

- The Moller polarimeter target location doesn't see a large dose overall
  - Photons dominate, we need to evaluate what kind of risk they pose

# Moller polarimeter detector

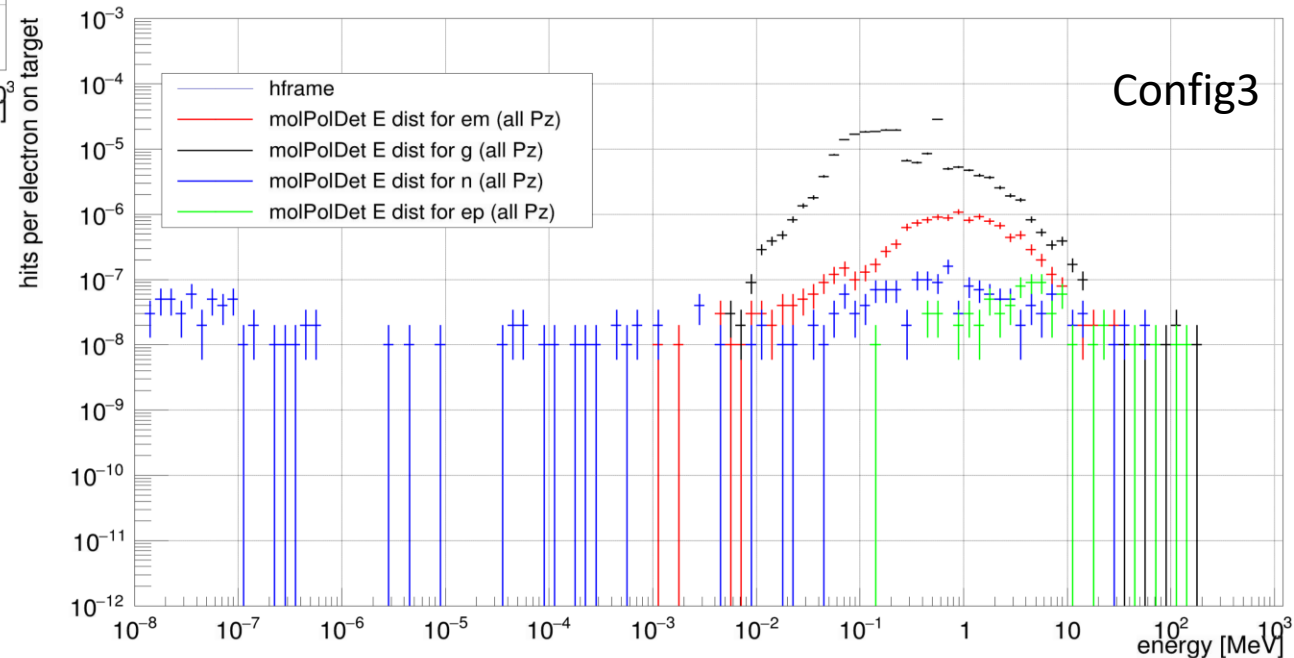
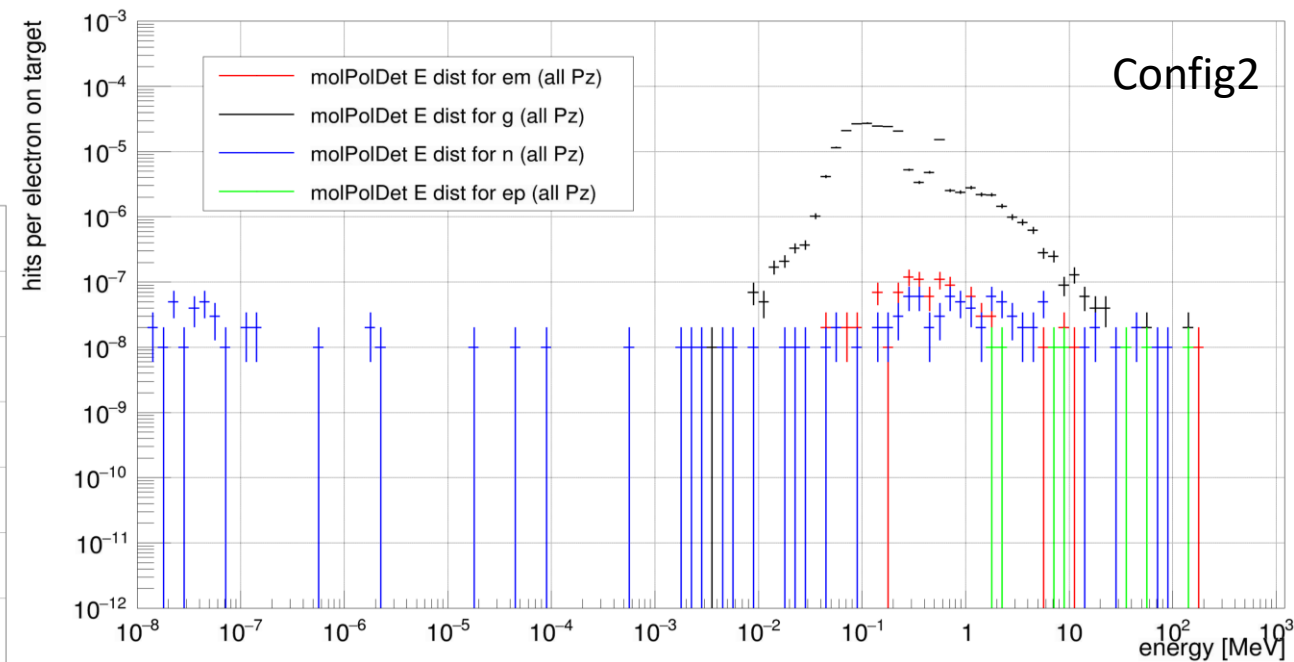
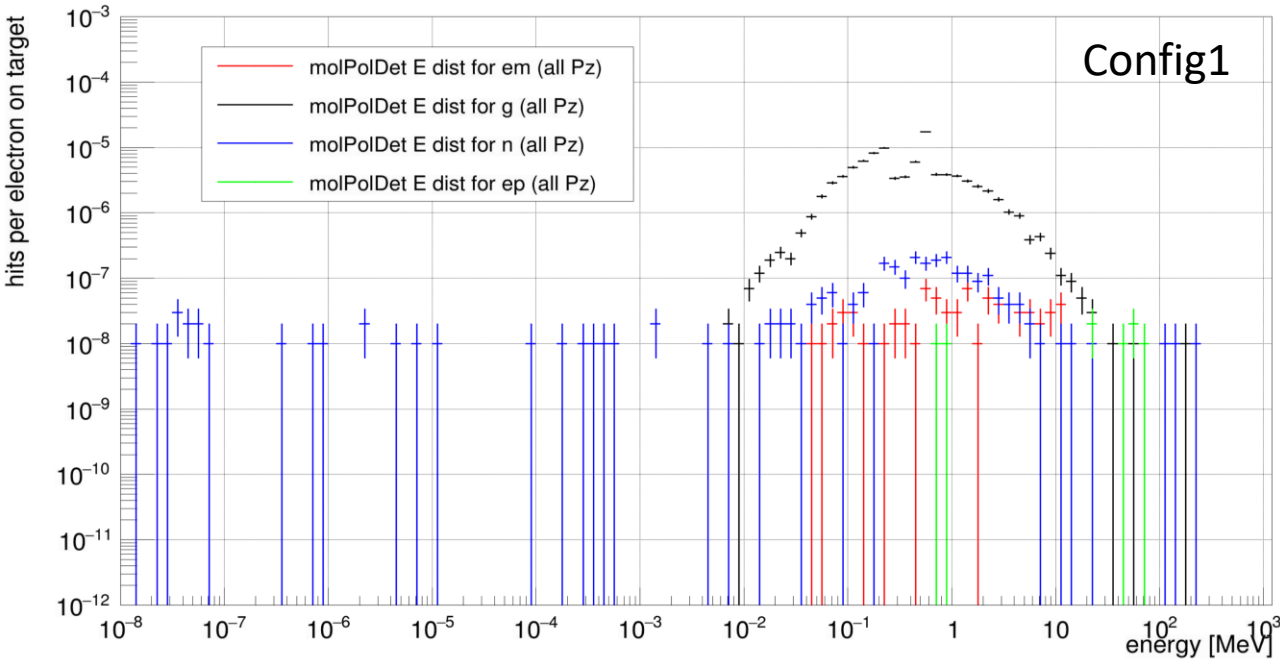

- The polarimeter detector sees a significant photon increase with the removal of the US wall
  - This can be remedied with local shielding
- Config3 sees a 10 fold increase in electrons
  - Will need to be investigated

# Beamline US target:

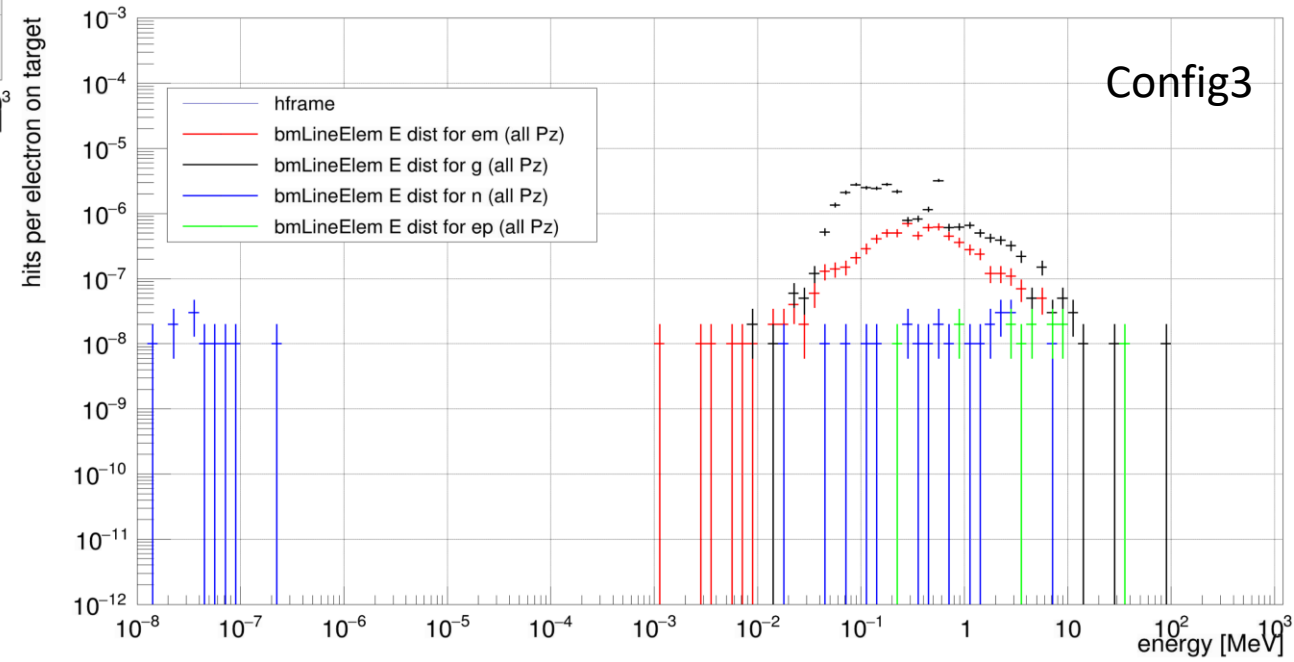
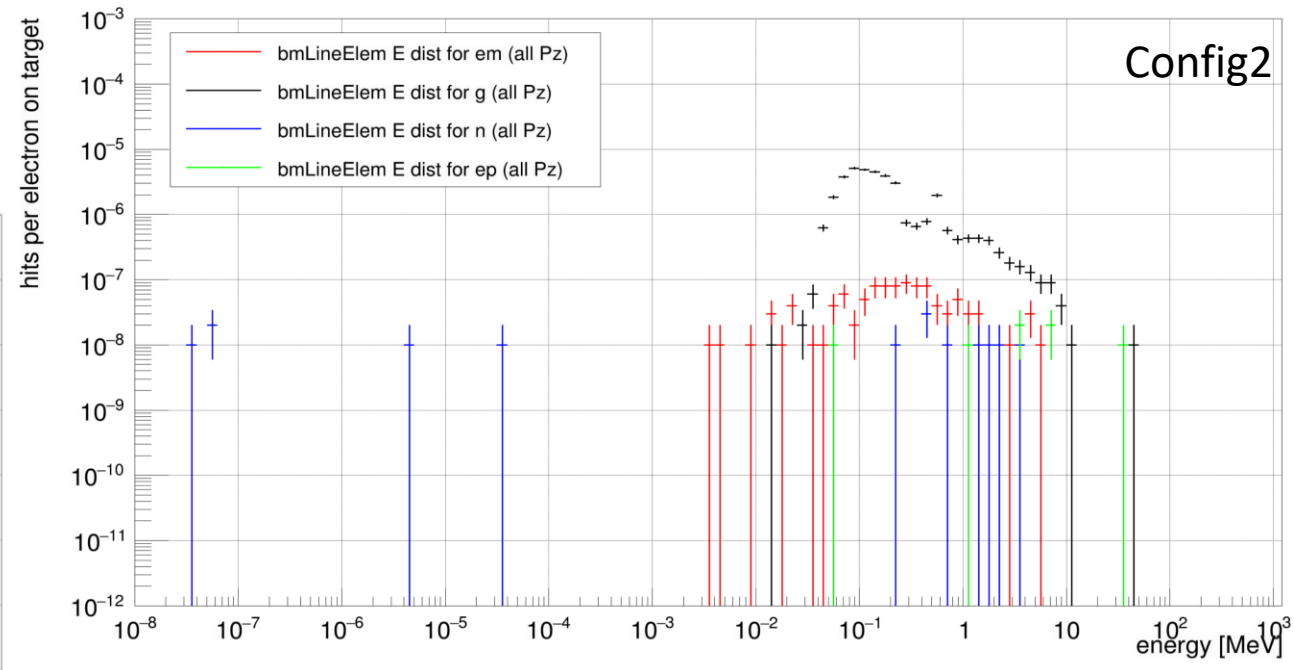
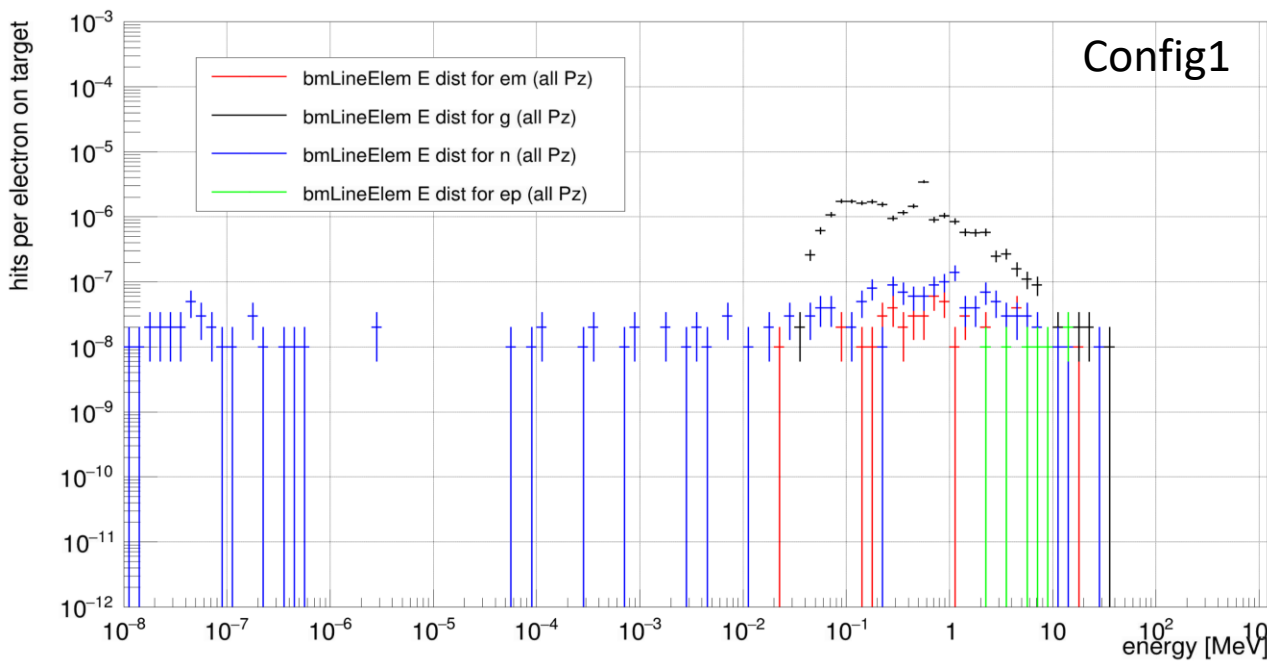

- Same thing as for the Moller polarimeter detector can be seen on the beamline US of the target

# Next steps

- Evaluation of the HE neutron rate at the hall roof will give us a feel for the increase at the boundary dose
  - A proposed drop of approximately 1.25m of the roof will increase the rate through the hole. Will need to be evaluated
- Understand the increase in R2-3 (including primaries?!)
  - Possible solution would be to reduce the inner radius of the barite (would probably reduce US doses)
- SBS does increase in config3 will need to be evaluated
  - The beam right side (where a lot of electronics live) will need to be fleshed out in the simulation

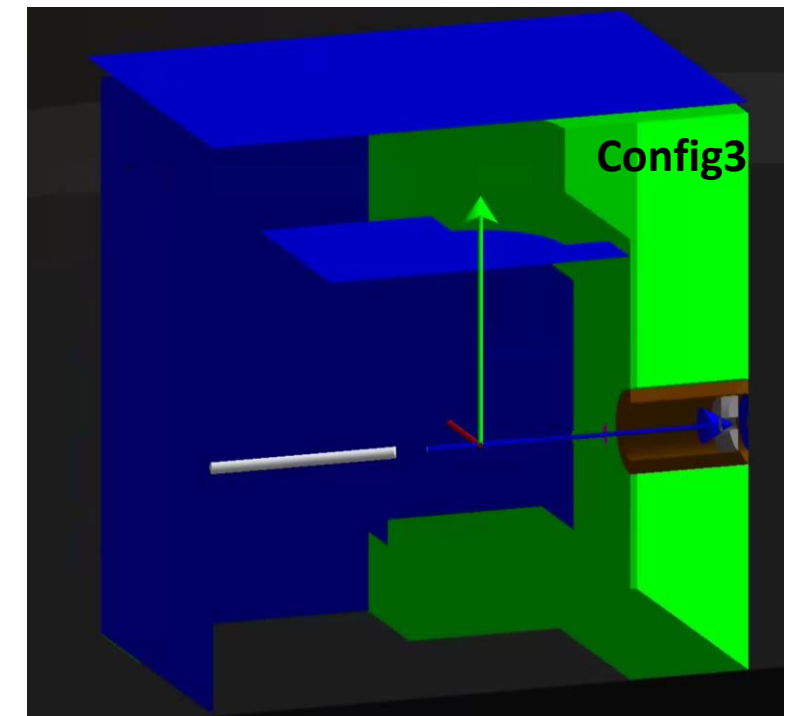
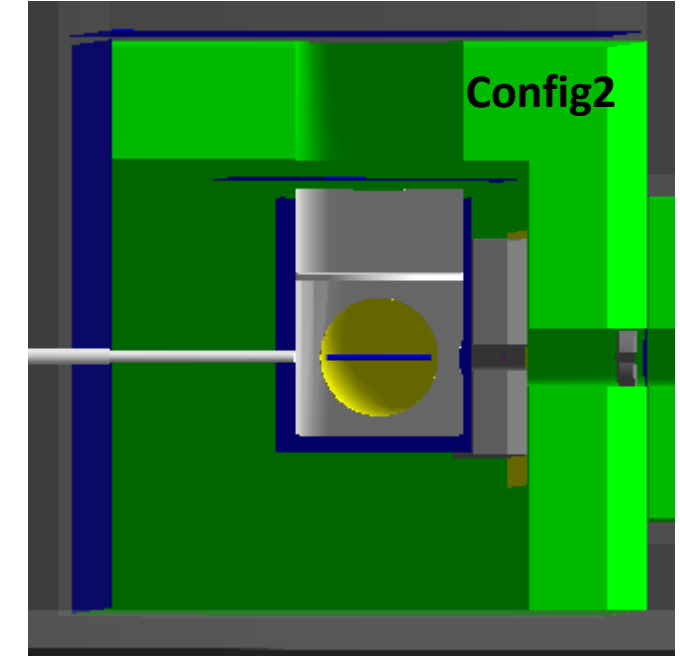

# Other stuff

# Beamline US target electronics:

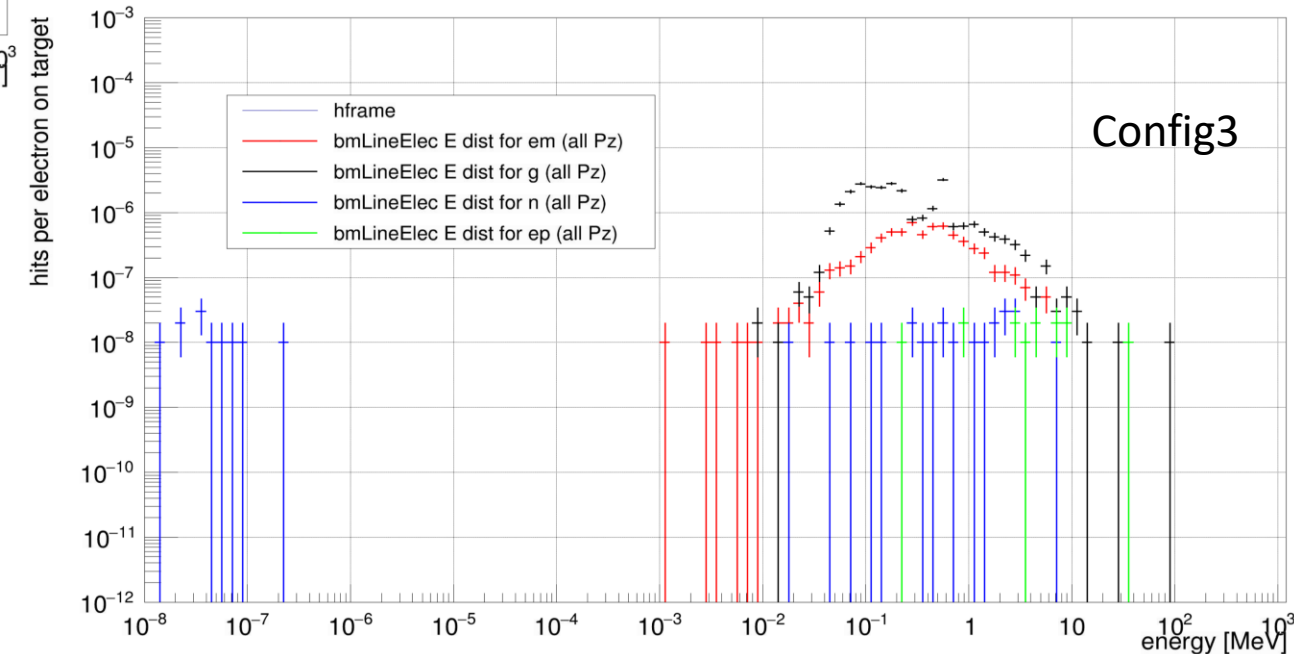
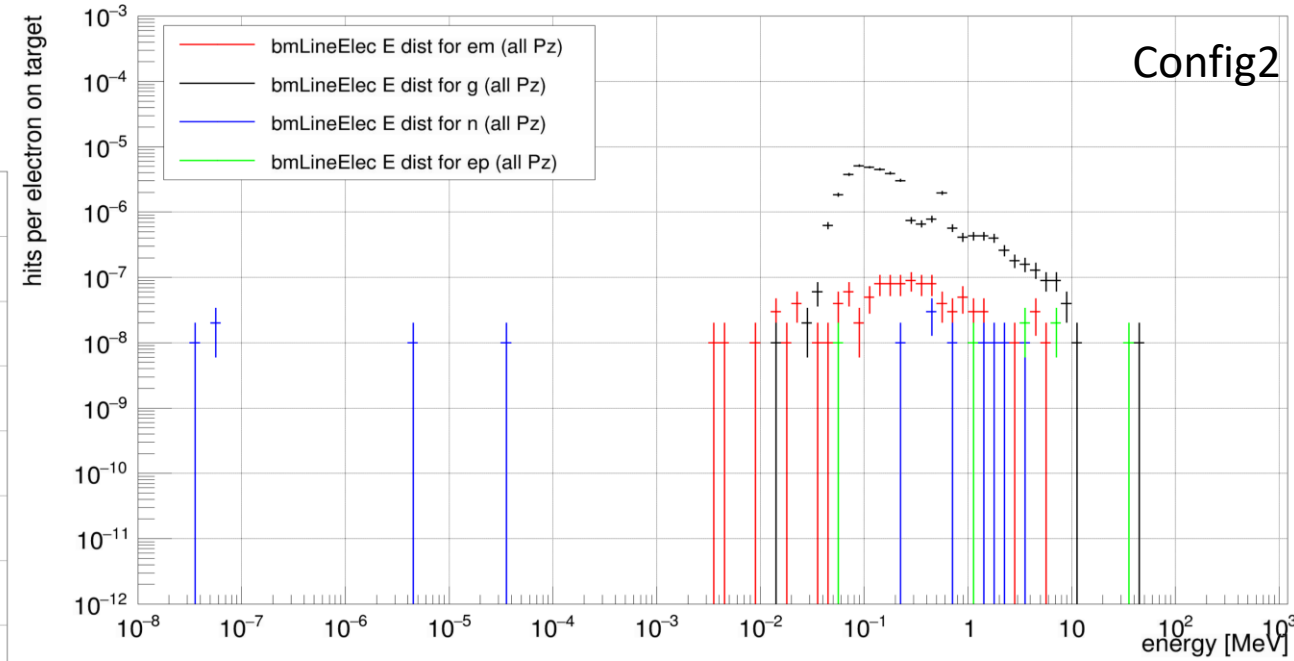
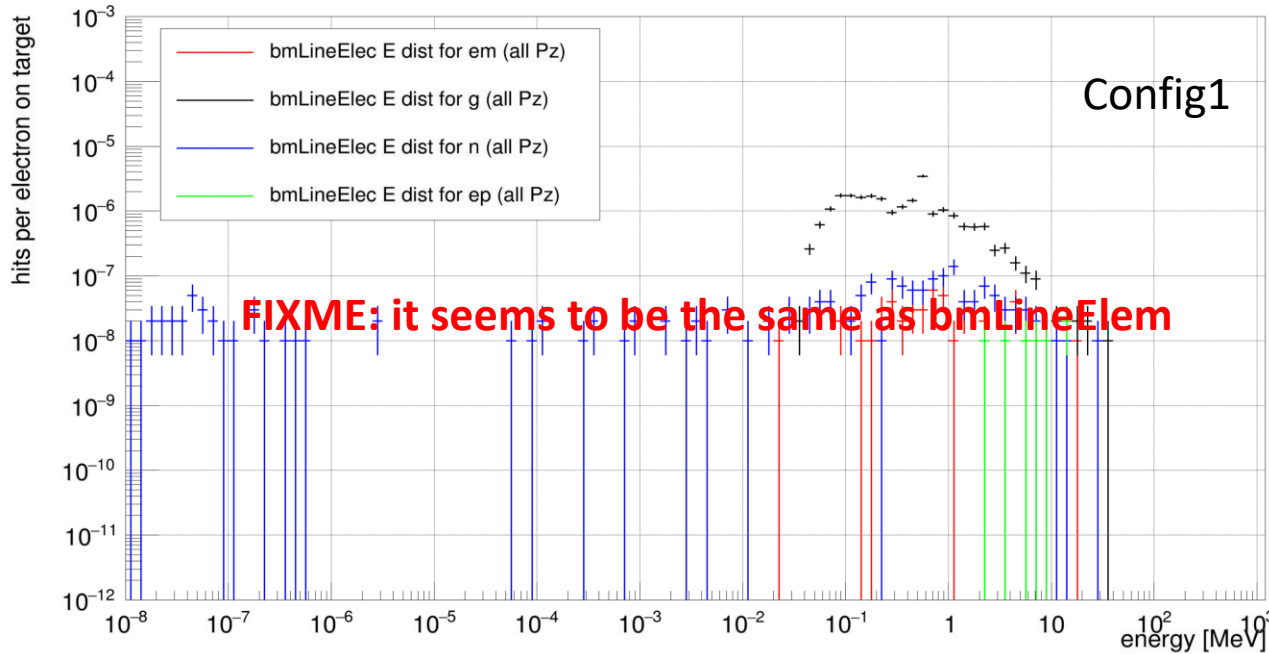

- Same thing as for the Moller polarimeter detector can be seen on the beamline US of the target and the electronics underneath



# Config 4 (from default/config1)

- asdf

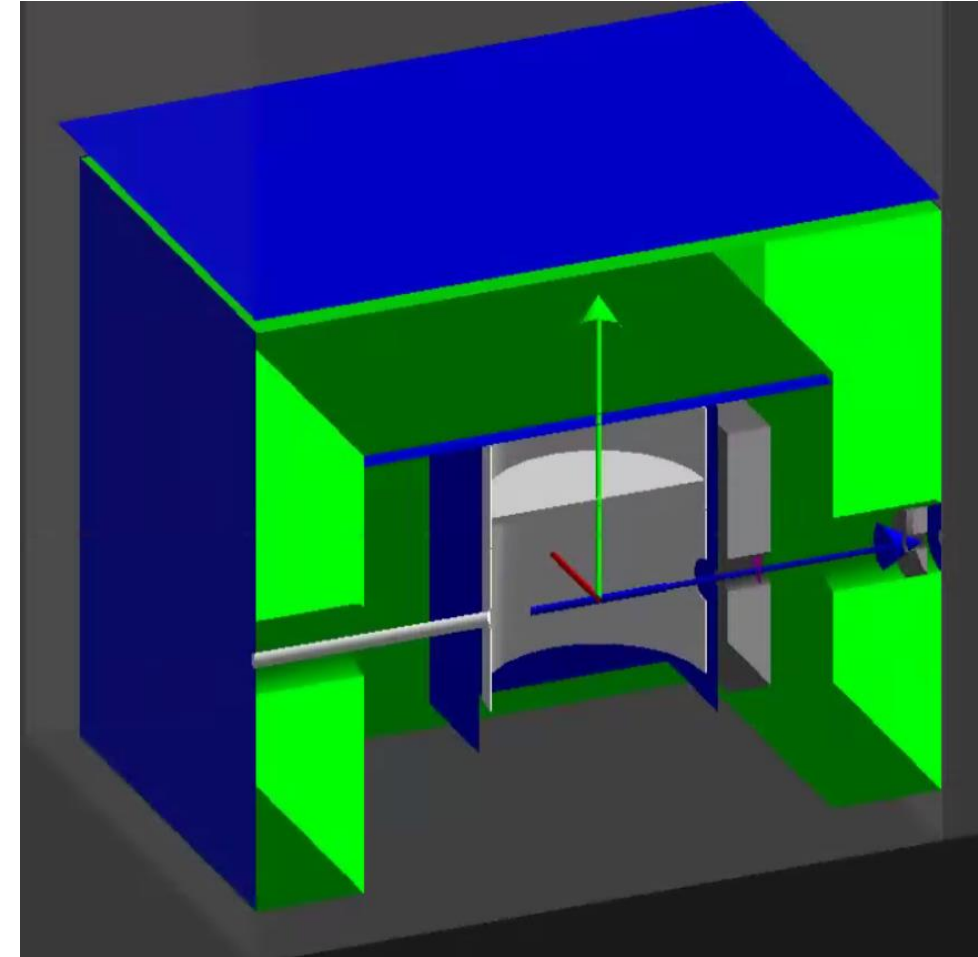

# What is the radiation level around the target?

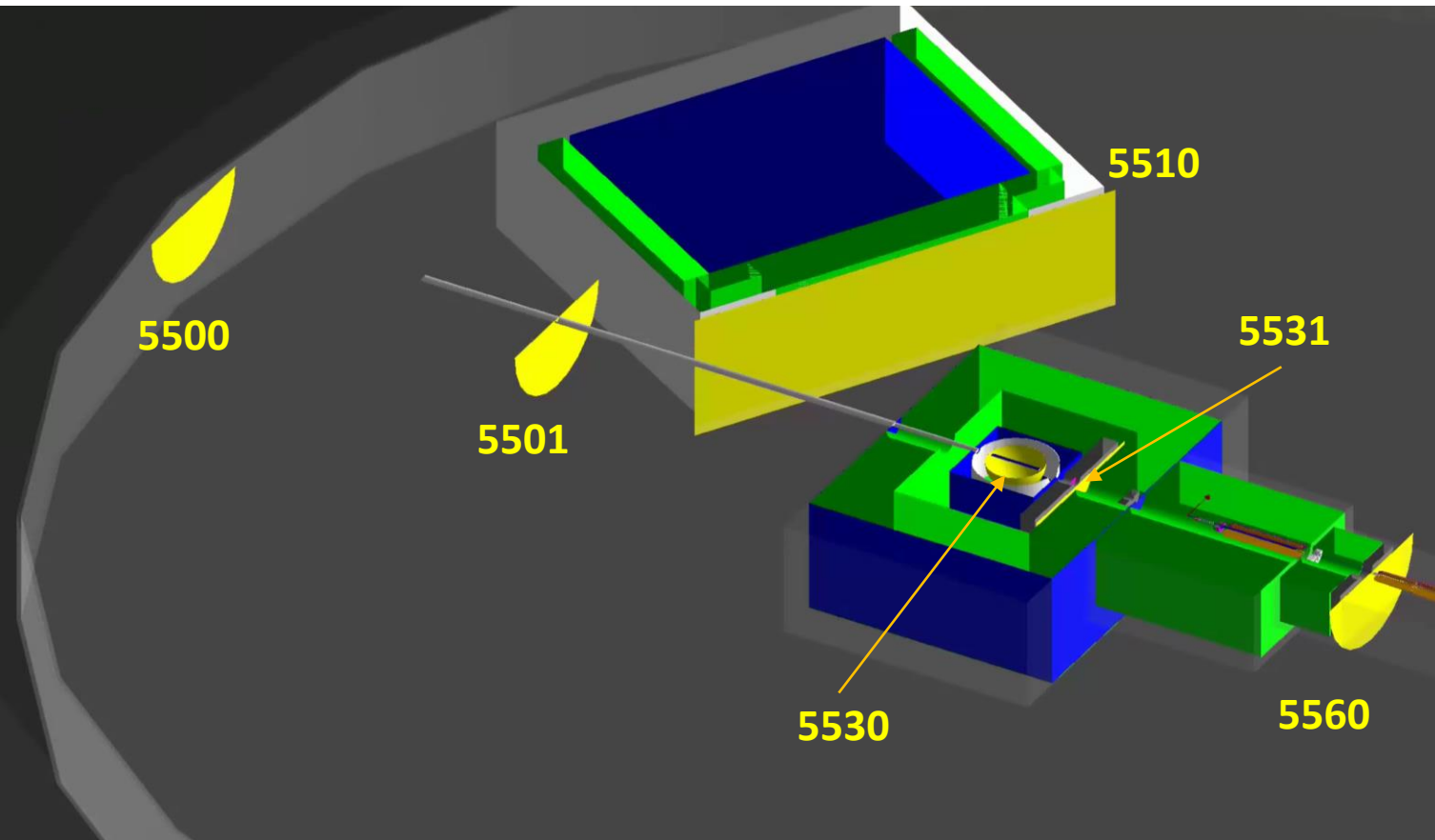

- Look at 5530
  - Radiation levels are based on energy deposition so it would be hard to estimate what effect we would have without a preliminary design
  - However we can take a look at the spectrum of particles and get an idea
- 
- Other questions:
    - for a 4in OD Viton o-ring located approximately 1m above and below the center of the target what would be the radiation seen over the lifetime of the experiment?

# Total Ionizing Dose back of the envelope calculations

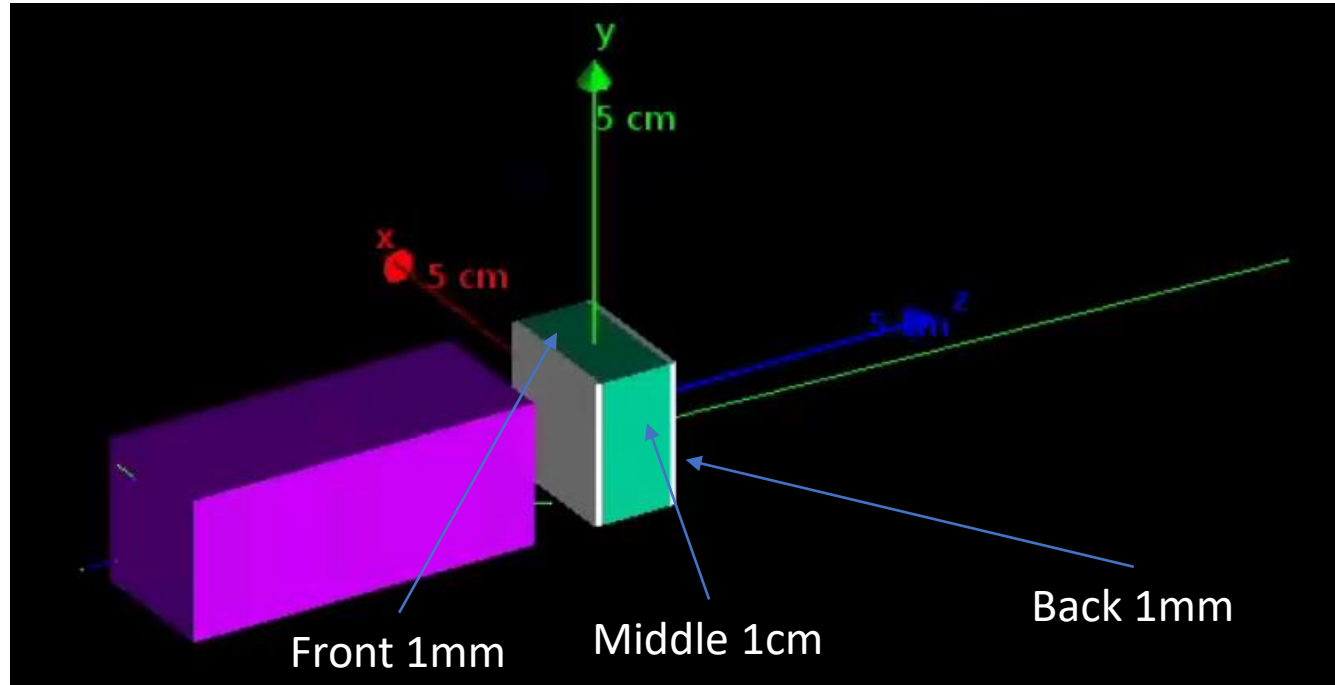

- Simple G4 simulation: <https://github.com/cipriangal/simple-tid>
- Setup has 4 volumes (2x2 cm transversely):
  - Purple: “shield” material in front of material you want to calculate TID
  - White: two 1 mm thick pieces of material for which TID is done
  - Green: 1 cm thick piece of material for which TID is done
- Input is needed for the spectrum of the gammas, electrons, positrons and neutrons that impact the material (or zone where the material is located)
  - This is generally obtained from the main remoll simulation
- Simulation samples from these inputs and puts particles uniformly on the surface of the shield leaving G4 to do the rest of the tracking
  - Output is a console text with energy deposition
- Materials, thicknesses and species needs to be modified by hand in the appropriate source files

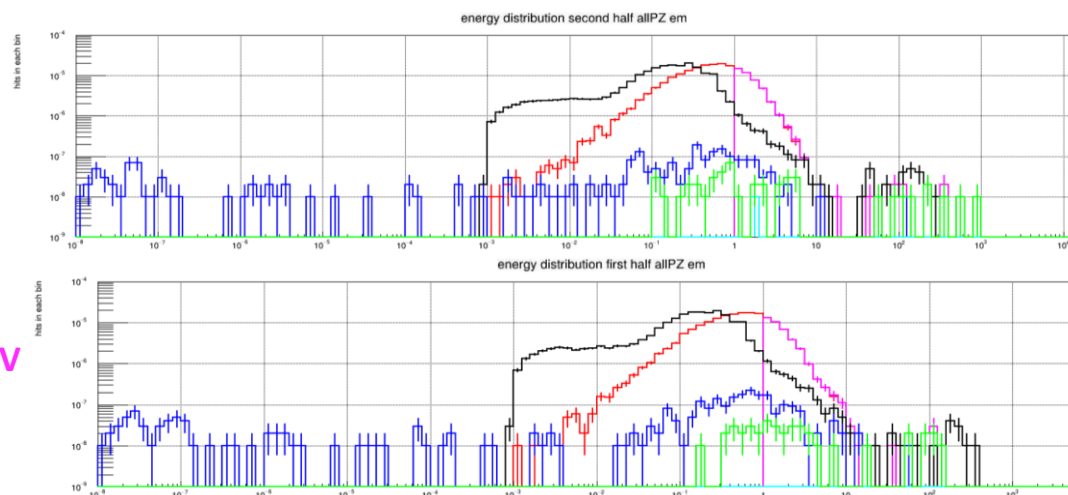

Black: gamma  
Red: e- and pi-  
Green: e+ and pi+  
Blue: neutrons  
Magenta: “e+/-” E>1MeV  
Cyan: primary E>1MeV

# Questions looking for answers

- What are the radiation levels around the target?
- Can we have a 2m hole through the shielding on the top of the target?
- Can we replace the lead wall with heavy concrete?
- Can we remove fully or partially the shielding US of the target?
- Can we optimize (reduce) the shielding without significantly increasing the radiation levels for the electronics?

# Summary

- What are the radiation levels around the target?

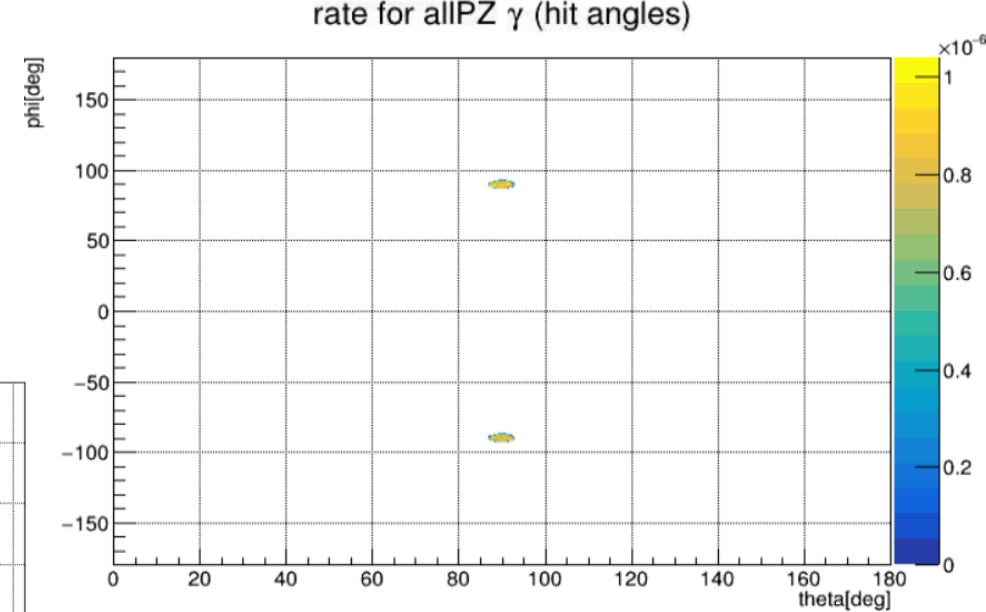
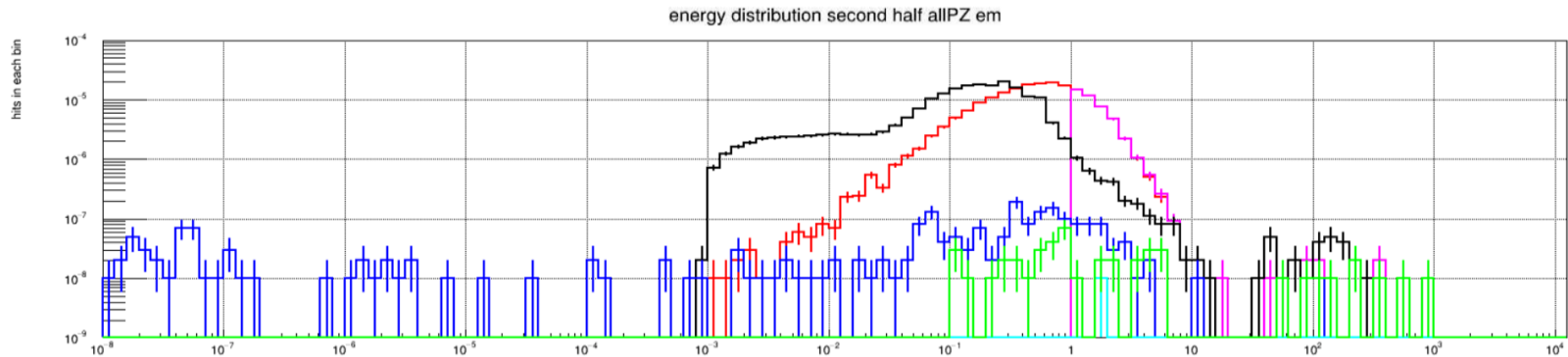

Total particles at 1m vertically over tgt for Experiment	particle per e- on target	Radiation (divide by thickness) [rad]		
		first 1mm	mid 1cm	last 1mm
4.96E+18	4.11E-04	5.85E+03	6.63E+03	6.21E+03
4.36E+18	3.61E-04	4.89E+02	5.12E+02	4.70E+02
1.04E+16	8.60E-07	1.24E+03	1.31E+03	1.27E+03
6.05E+16	5.01E-06	4.07E+02	4.07E+02	3.56E+02
		<b>7.99E+03</b>	<b>8.86E+03</b>	<b>8.30E+03</b>

- The TID for Viton after 2cm of Stainless steel is approximately 4kRad over the entire life of the experiment (factor of 2 from taking both top and bottom)
- The photons are the largest contributor
  - The positrons are under-sampled creating an overestimate

# Summary

- Can we replace the lead wall with heavy concrete?
- Can we remove fully or partially the shielding US of the target?

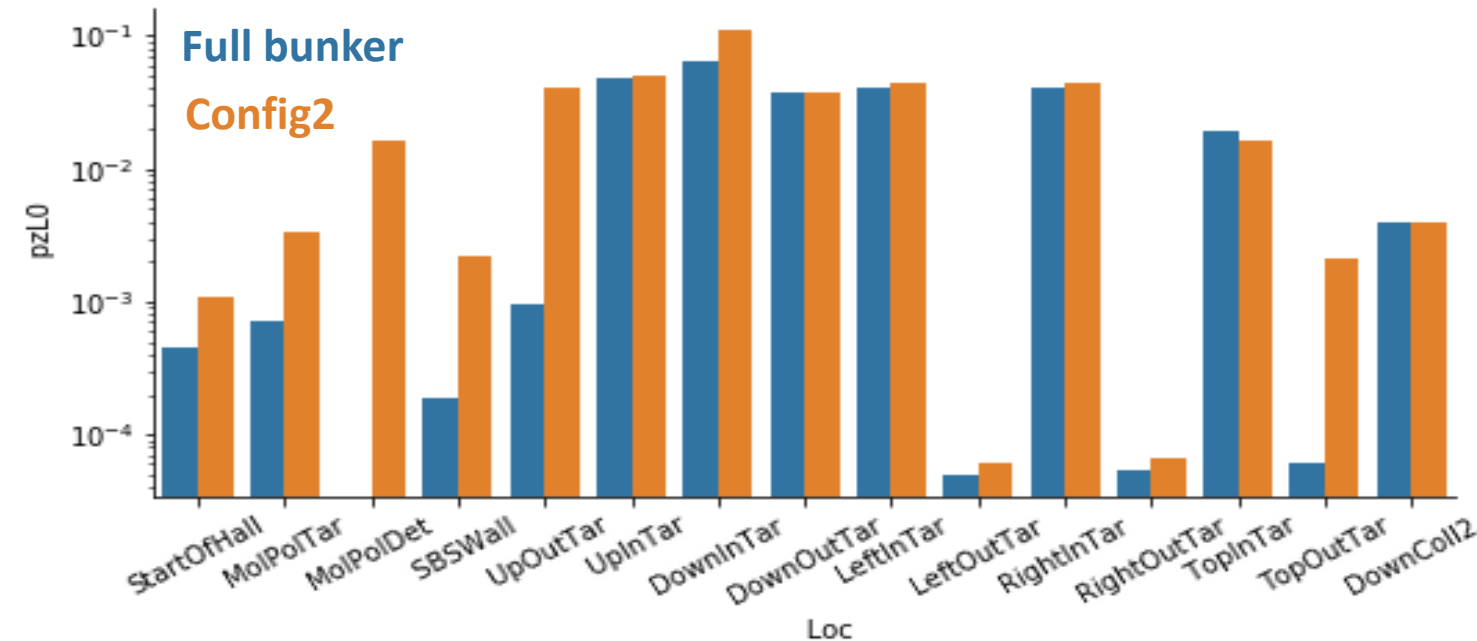
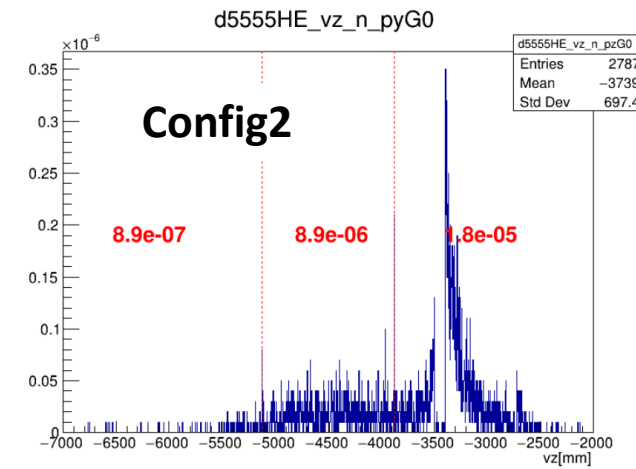
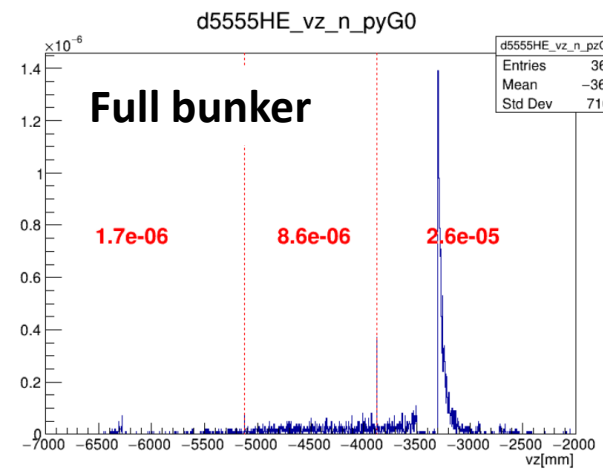

- The Pb wall creates quite a large prompt radiation field inside the bunker through splashback
- If we look upstream the increases in radiation due to the removal of the upstream wall are almost balanced by the replacement of the Lead
- Downstream we see very small effects due to this replacement
  - We need to look at the MD region



# Todos

- Implement a reasonable semicircle covering the DS half of the hole above the target chamber
- Evaluate the changes due to the Config2 geometry downstream of Collimator1/2
  - Look at the MD region
  - Look at the Hall walls
- Implement a mixed material replacement for the Pb wall
  - We will probably still need high Z at close to the beamline (shield it to allow for easy access to the target chamber)
  - Could we combine the Pb wall and Downstream bunker wall?
    - Use barite concrete for the downstream wall?!
- Evaluate the increases at the SBS bunker and through the sides of the target bunker shielding

# Spherical detector: theta vs phi (all pz) hits/eot

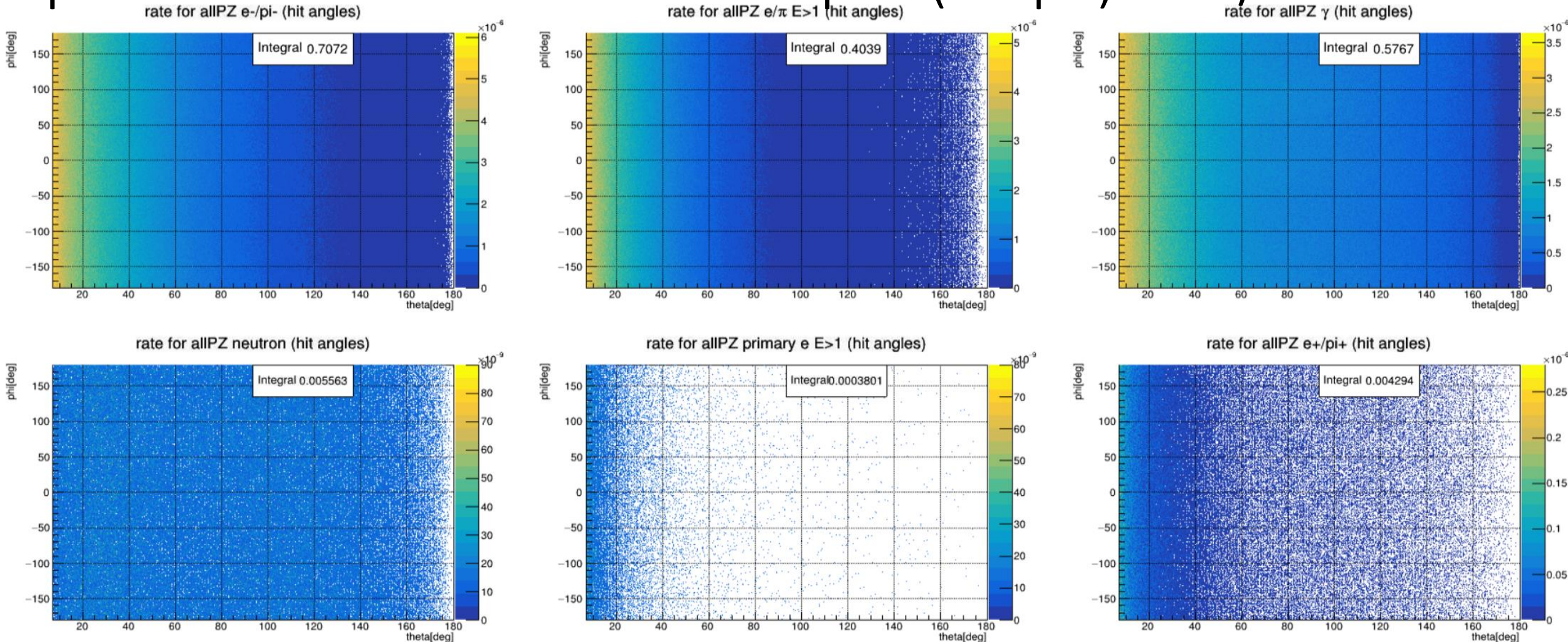

- Theta, phi are on the sphere centered on the target (R=700mm)
- This does not contain the fwd scattering angles that would go through the lead wall (angle <7deg)



# Spherical detector: theta vs phi (all pz): hits \* E/eot

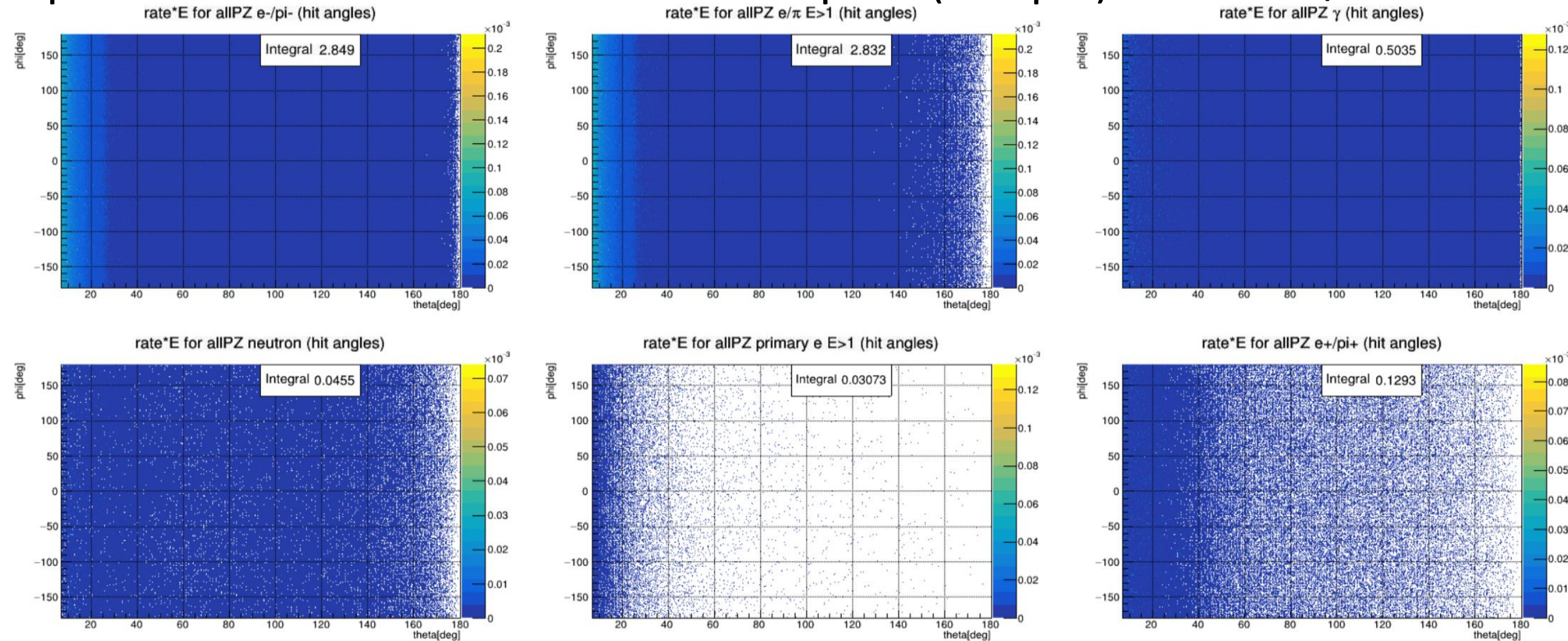

- This does not contain the fwd scattering angles that would go through the lead wall (angle <7deg)
- Clearly dominated by small angles and electromagnet radiation

# Spherical detector: allPZ US half

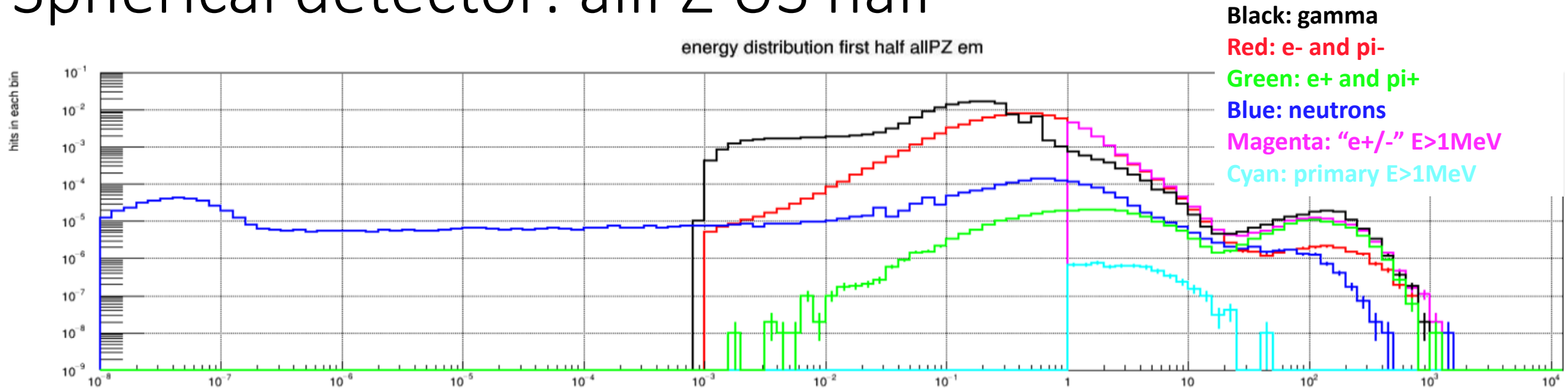

- This contains the entire sphere (except the primary electrons before hitting the target – so they are not double counted)
- This is the downstream half of the sphere
- We can see that while the neutrons are several of orders of magnitude down compared to EM they are not completely negligible

# Spherical detector: allPZ DS half

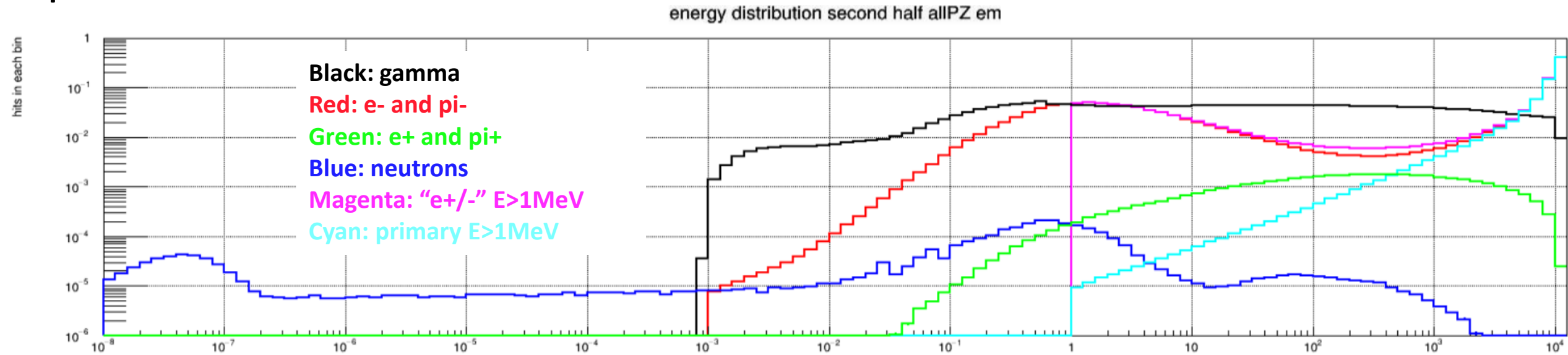

- This is the downstream half of the sphere
- To get a better picture we would need some information of regions that are of concern from the target group
  - @Silviu: what theta, phi region is worth looking at and what kind of power absorption can we assume so that we can estimate in units of "rad"



# Spherical detector: theta vs phi (outgoing): hits

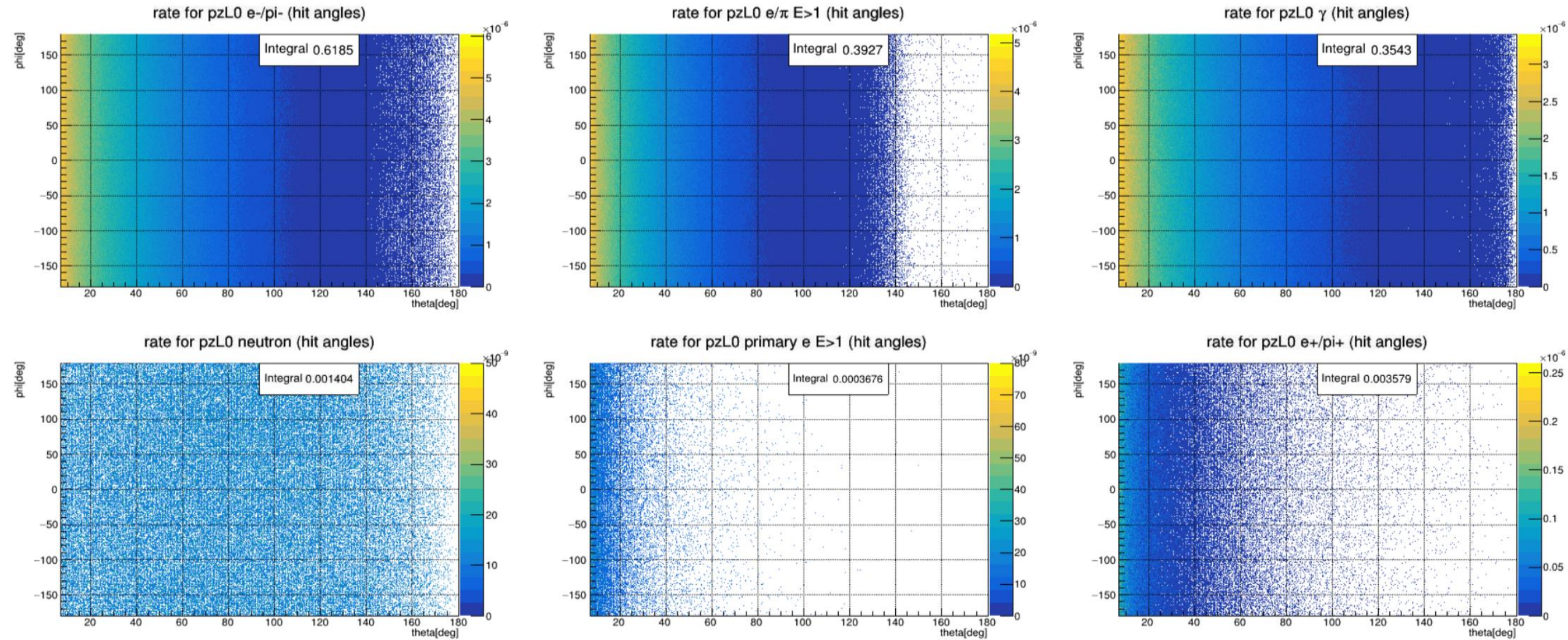



# Spherical detector: theta vs phi (incoming): hits

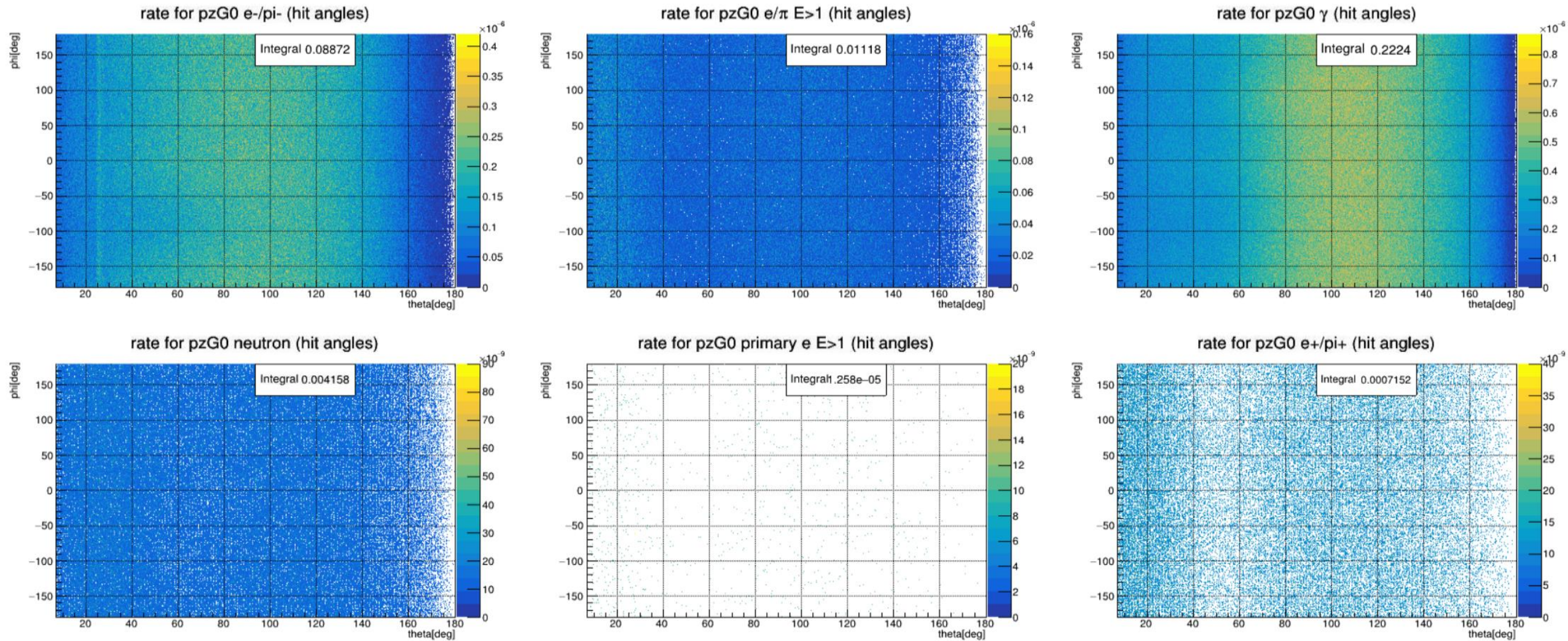



# Viton o-rings:

rate for allPZ  $\gamma$  (hit angles)

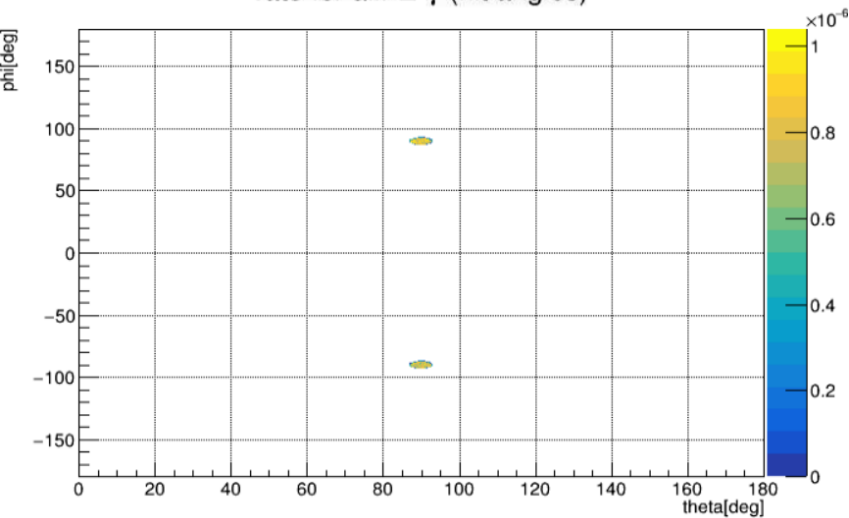

- Look at the spherical detector with fiducial cuts  $R < 35\text{mm}$  (@700mm) which should be equivalent to 10cm at 1m
- Look at the energy spectrum for the two halves of the detector
  - Sum them to evaluate energy deposition in Viton

energy distribution second half allPZ em

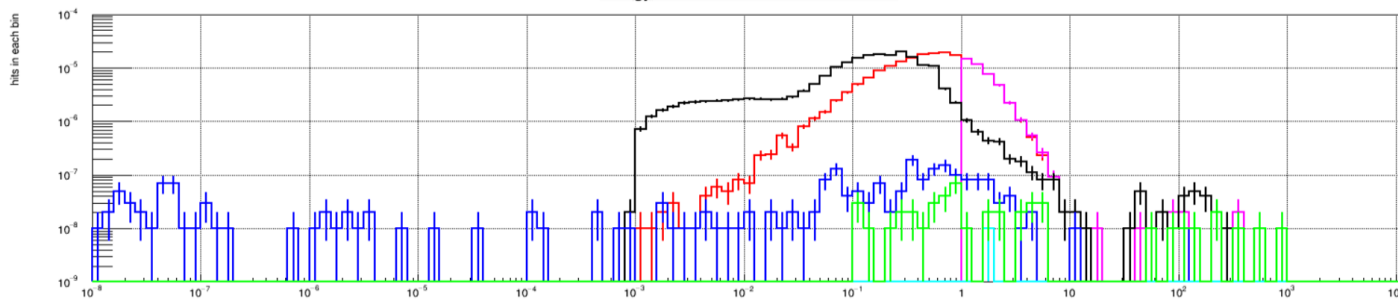

energy distribution first half allPZ em

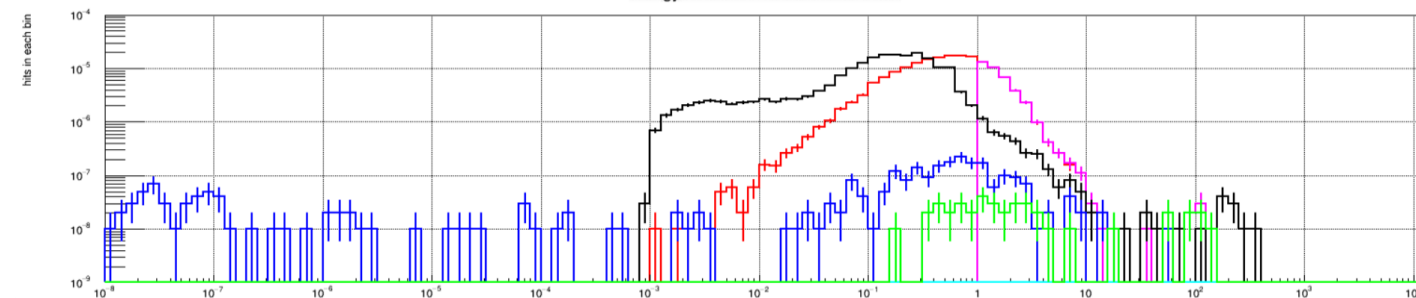

**Black:** gamma  
**Red:** e- and pi-  
**Green:** e+ and pi+  
**Blue:** neutrons  
**Magenta:** "e+/-" E>1MeV  
**Cyan:** primary E>1MeV

# Total Ionizing Dose back of the envelope calculations

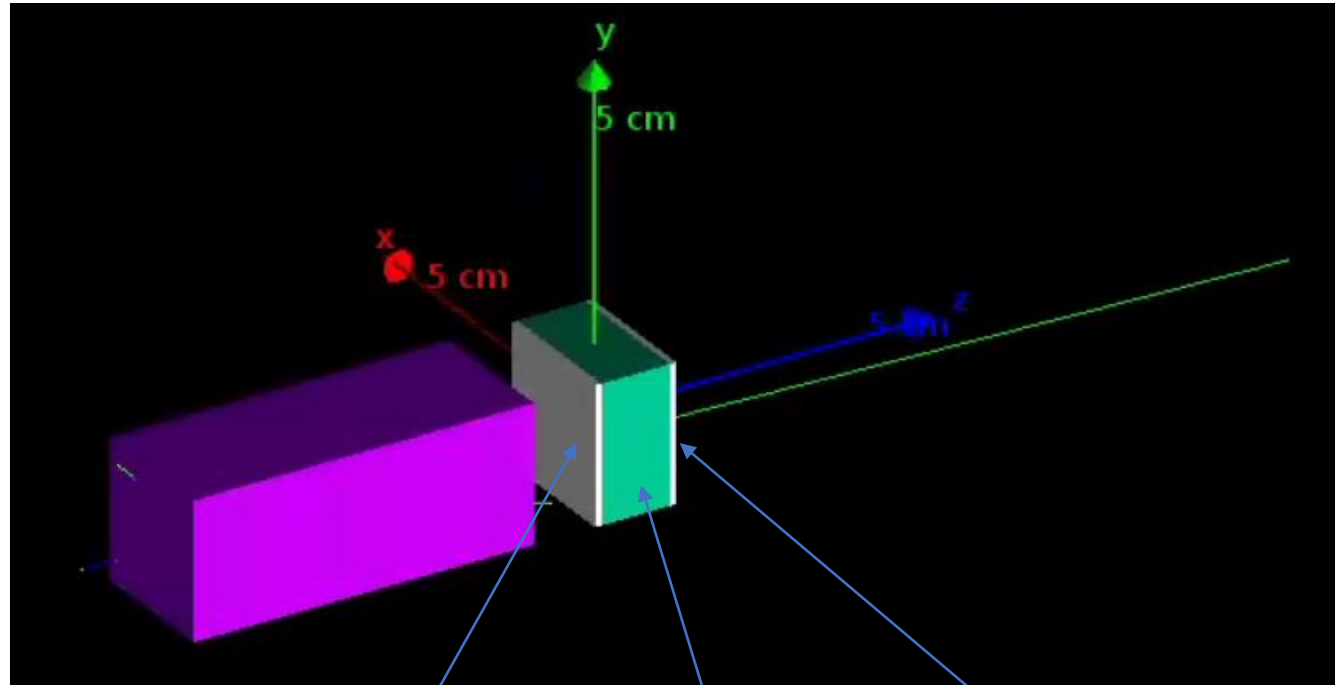

Front 1mm Middle 1cm Back 1mm

**Black:** gamma  
**Red:** e<sup>-</sup> and pi<sup>-</sup>  
**Green:** e<sup>+</sup> and pi<sup>+</sup>  
**Blue:** neutrons  
**Magenta:** "e<sup>+/-</sup>" E>1MeV  
**Cyan:** primary E>1MeV

- Used the simulation setup we used for the TID calculation at the MD PMTs
- The “shield” here is 2cm of Al
- We sample electrons, positrons, photons and neutrons from the energy spectrum sum of US and DS (top and bottom)

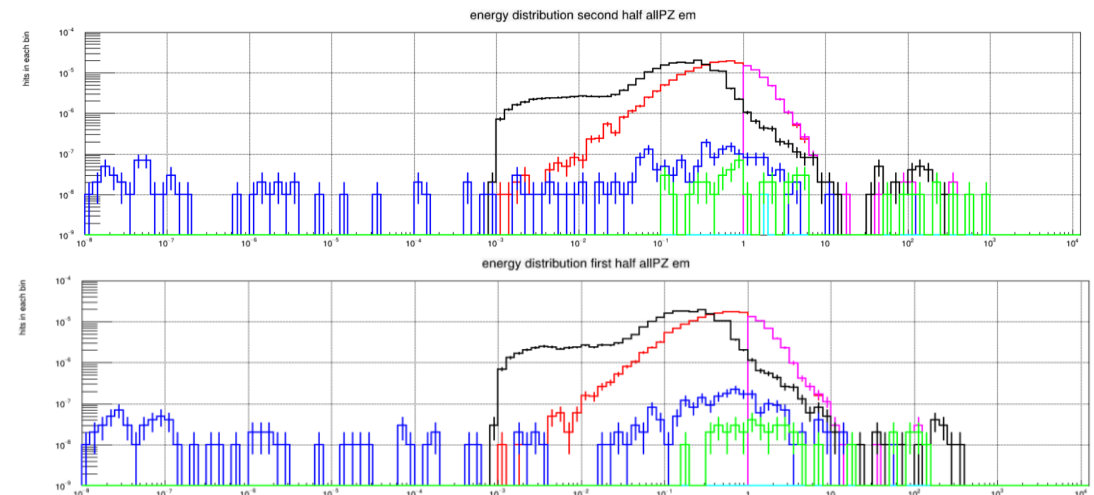

# Total Ionizing Dose back of the envelope calculations

11	1J [MeV]	6.24E+12					
12	Density of Viton[	1.8					
13	Surface of target	4					
14							
	Config	n-events	radiation[Gy]	RMS [Gy]	Per N	E deposit per particle [MeV]	
15	Front [dz=1mm]	5000000	7.24E-07	5.83E-09	1.45E-13	6.51E-04	
16	Mid [dz=1cm]	5000000	7.97E-07	3.75E-09	1.59E-13	7.16E-03	
17	gamma Back [dz=1mm]	5000000	7.31E-07	6.49E-09	1.46E-13	6.57E-04	
18							
19							
20	Front [dz=1mm]	5000000	5.96E-08	2.21E-09	1.19E-14	5.36E-05	
21	Mid [dz=1cm]	5000000	6.07E-08	2.21E-09	1.21E-14	5.46E-04	
22	electron Back [dz=1mm]	5000000	5.89E-08	2.44E-09	1.18E-14	5.29E-05	
23							
24							
25	Front [dz=1mm]	5000000	5.08E-05	6.08E-08	1.02E-11	4.57E-02	
26	Mid [dz=1cm]	5000000	5.34E-05	6.18E-08	1.07E-11	4.80E-01	
27	positron Back [dz=1mm]	5000000	5.27E-05	7.05E-08	1.05E-11	4.74E-02	
28							
29							
30	Front [dz=1mm]	5000000	2.50E-06	3.34E-08	5.00E-13	2.25E-03	
31	Mid [dz=1cm]	5000000	2.49E-06	1.41E-08	4.98E-13	2.24E-02	
32	neutrons Back [dz=1mm]	5000000	2.16E-06	3.40E-08	4.32E-13	1.94E-03	

- Calculate the mean energy deposition per particle for a 5e6 event sampled simulation
- Use that together with the information of the total number of particles per electron on target and the total electrons delivered to get energy deposition over the surface for each particle species

1	Viton with 2cm of Al in front			Total e on tgt	1.21E+22								
2		Energy deposited for entire run [MeV]			Energy deposited for entire run [J/cm2]			Energy deposited per particle on surface [MeV]					
3		first 1mm	mid 1cm	last 1mm	first 1mm	mid 1cm	last 1mm	first 1mm	mid 1cm	last 1mm	Total particles at 1m vertically over tgt for Experiment	particle per e-on target	
4	gamma	3.23E+15	3.56E+16	3.26E+15	2.03E-02	2.24E-01	2.05E-02	6.51E-04	7.16E-03	6.57E-04	4.96E+18	4.11E-04	
5	electron	2.33E+14	2.38E+15	2.31E+14	1.47E-03	1.50E-02	1.45E-03	5.36E-05	5.46E-04	5.29E-05	4.36E+18	3.61E-04	
6	positrons	4.74E+14	4.98E+15	4.92E+14	2.99E-03	3.14E-02	3.10E-03	4.57E-02	4.80E-01	4.74E-02	1.04E+16	8.60E-07	
7	neutron	1.36E+14	1.35E+15	1.17E+14	8.56E-04	8.52E-03	7.39E-04	2.25E-03	2.24E-02	1.94E-03	6.05E+16	5.01E-06	
8	<b>Sum</b>	<b>4.07E+15</b>	<b>4.43E+16</b>	<b>4.10E+15</b>	<b>2.56E-02</b>	<b>2.79E-01</b>	<b>2.58E-02</b>	<b>4.86E-02</b>	<b>5.10E-01</b>	<b>5.00E-02</b>			

# Total Ionizing Dose back of the envelope calculations:Al

1	Viton with 2cm of Al in front	Total e on tgt			1.21E+22							
2		Energy deposited for entire run [MeV]			Energy deposited for entire run [J/cm2]			Energy deposited per particle on surface [MeV]				
3		first 1mm	mid 1cm	last 1mm	first 1mm	mid 1cm	last 1mm	first 1mm	mid 1cm	last 1mm	Total particles at 1m vertically over tgt for Experiment	particle per e-on target
4	gamma	3.23E+15	3.56E+16	3.26E+15	2.03E-02	2.24E-01	2.05E-02	6.51E-04	7.16E-03	6.57E-04	4.96E+18	4.11E-04
5	electron	2.33E+14	2.38E+15	2.31E+14	1.47E-03	1.50E-02	1.45E-03	5.36E-05	5.46E-04	5.29E-05	4.36E+18	3.61E-04
6	positrons	4.74E+14	4.98E+15	4.92E+14	2.99E-03	3.14E-02	3.10E-03	4.57E-02	4.80E-01	4.74E-02	1.04E+16	8.60E-07
7	neutron	1.36E+14	1.35E+15	1.17E+14	8.56E-04	8.52E-03	7.39E-04	2.25E-03	2.24E-02	1.94E-03	6.05E+16	5.01E-06
8	<b>Sum</b>	<b>4.07E+15</b>	<b>4.43E+16</b>	<b>4.10E+15</b>	<b>2.56E-02</b>	<b>2.79E-01</b>	<b>2.58E-02</b>	<b>4.86E-02</b>	<b>5.10E-01</b>	<b>5.00E-02</b>		

1	Viton with 2cm of Al in front			1Gy= 100 rad		
2		Radiation (divide by thickness) [rad]				
3		Total particles at 1m vertically over tgt for Experiment	particle per e-on target	first 1mm	mid 1cm	last 1mm
4	gamma	4.96E+18	4.11E-04	1.13E+04	1.24E+04	1.14E+04
5	electron	4.36E+18	3.61E-04	8.16E+02	8.32E+02	8.07E+02
6	positrons	1.04E+16	8.60E-07	1.66E+03	1.74E+03	1.72E+03
7	neutron	6.05E+16	5.01E-06	4.75E+02	4.74E+02	4.11E+02
8	<b>Sum</b>			<b>1.42E+04</b>	<b>1.55E+04</b>	<b>1.43E+04</b>

- The TID for Viton is approximately 7500rad over the entire life of the experiment (factor of 2 from taking both top and bottom)
- The largest contributor will be photons

# Total Ionizing Dose back of the envelope calculations: SS

14		Config	n-events	radiation[Gy]	RMS [Gy]	Per N	E deposit per particle [MeV]
15	gamma	Front [dz=1mm]	5000000	3.75E-07	5.24E-09	7.50E-14	3.37E-04
16		Mid [dz=1cm]	5000000	4.25E-07	4.40E-09	8.50E-14	3.82E-03
17		Back [dz=1mm]	5000000	3.98E-07	6.04E-09	7.96E-14	3.58E-04
18							
19							
20	electron	Front [dz=1mm]	5000000	3.57E-08	2.07E-09	7.14E-15	3.21E-05
21		Mid [dz=1cm]	5000000	3.74E-08	2.03E-09	7.48E-15	3.36E-04
22		Back [dz=1mm]	5000000	3.43E-08	2.12E-09	6.86E-15	3.08E-05
23							
24							
25	positron	Front [dz=1mm]	5000000	3.79E-05	7.10E-08	7.58E-12	3.41E-02
26		Mid [dz=1cm]	5000000	4.02E-05	7.19E-08	8.04E-12	3.61E-01
27		Back [dz=1mm]	5000000	3.88E-05	7.96E-08	7.76E-12	3.49E-02
28							
29							
30	neutrons	Front [dz=1mm]	5000000	2.14E-06	3.02E-08	4.28E-13	1.92E-03
31		Mid [dz=1cm]	5000000	2.14E-06	1.36E-08	4.28E-13	1.92E-02
32		Back [dz=1mm]	5000000	1.87E-06	3.52E-08	3.74E-13	1.68E-03

- It looks like the spectrum for the positrons is suffering from low statistics
  - This may lead to artificially “large” values of energy deposition per particle (2-3 orders of magnitude larger than e-,gamma)
- We need a higher stats simulation
  - At this point I guess the positron radiation dose is a conservative estimate

**Black: gamma**  
**Red: e- and pi-**  
**Green: e+ and pi+**  
**Blue: neutrons**  
**Magenta: “e+/-” E>1MeV**  
**Cyan: primary E>1MeV**

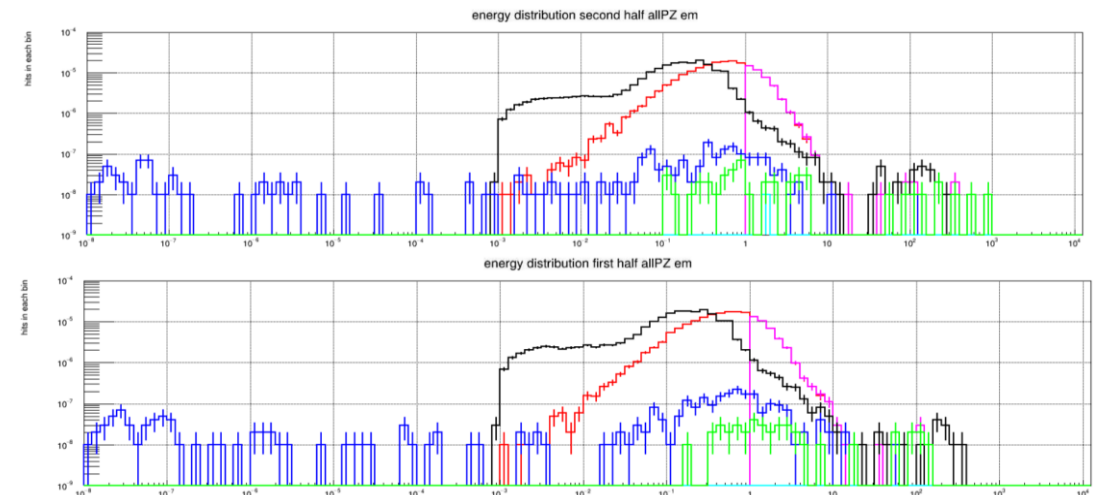

# Total Ionizing Dose back of the envelope calculations: SS

1	Viton with 2cm of Stainless steel in front	Total e on tgt			1.21E+22							
2		Energy deposited for entire run [MeV]			Energy deposited for entire run [J/cm2]			Energy deposited per particle on surface [MeV]				
3		first 1mm	mid 1cm	last 1mm	first 1mm	mid 1cm	last 1mm	first 1mm	mid 1cm	last 1mm	Total particles at 1m vertically over tgt for Experiment	particle per e-on target
4	gamma	1.67E+15	1.90E+16	1.78E+15	1.05E-02	1.19E-01	1.12E-02	3.37E-04	3.82E-03	3.58E-04	4.96E+18	4.11E-04
5	electron	1.40E+14	1.46E+15	1.34E+14	8.80E-04	9.22E-03	8.46E-04	3.21E-05	3.36E-04	3.08E-05	4.36E+18	3.61E-04
6	positrons	3.54E+14	3.75E+15	3.62E+14	2.23E-03	2.36E-02	2.28E-03	3.41E-02	3.61E-01	3.49E-02	1.04E+16	8.60E-07
7	neutron	1.16E+14	1.16E+15	1.02E+14	7.33E-04	7.33E-03	6.40E-04	1.92E-03	1.92E-02	1.68E-03	6.05E+16	5.01E-06
8	<b>Sum</b>	<b>2.28E+15</b>	<b>2.53E+16</b>	<b>2.37E+15</b>	<b>1.44E-02</b>	<b>1.60E-01</b>	<b>1.49E-02</b>	<b>3.64E-02</b>	<b>3.85E-01</b>	<b>3.69E-02</b>		

Total particles at 1m vertically over tgt for Experiment	particle per e-on target	Radiation (divide by thickness) [rad]		
		first 1mm	mid 1cm	last 1mm
4.96E+18	4.11E-04	5.85E+03	6.63E+03	6.21E+03
4.36E+18	3.61E-04	4.89E+02	5.12E+02	4.70E+02
1.04E+16	8.60E-07	1.24E+03	1.31E+03	1.27E+03
6.05E+16	5.01E-06	4.07E+02	4.07E+02	3.56E+02
		<b>7.99E+03</b>	<b>8.86E+03</b>	<b>8.30E+03</b>

- The TID for Viton is approximately 4kRad over the entire life of the experiment (factor of 2 from taking both top and bottom)
  - The SS almost improves things by a factor of 2
- The photons remain the largest contributor



# What is does the lead wall do?

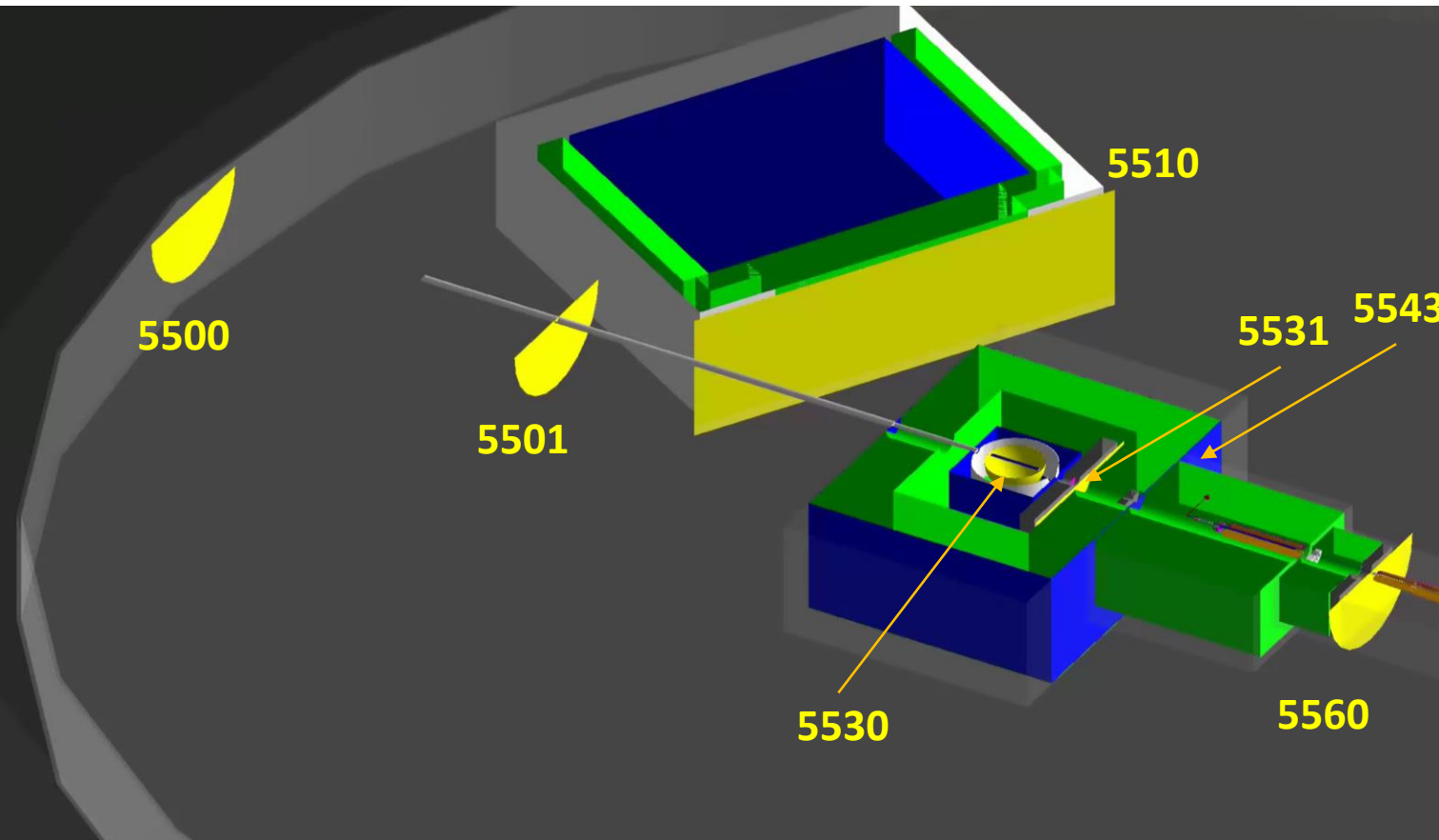

- Look at 5547 (before the wall) and 5531 (after the wall)



# Hits/EOT with $pZ > 0$ (before wall)

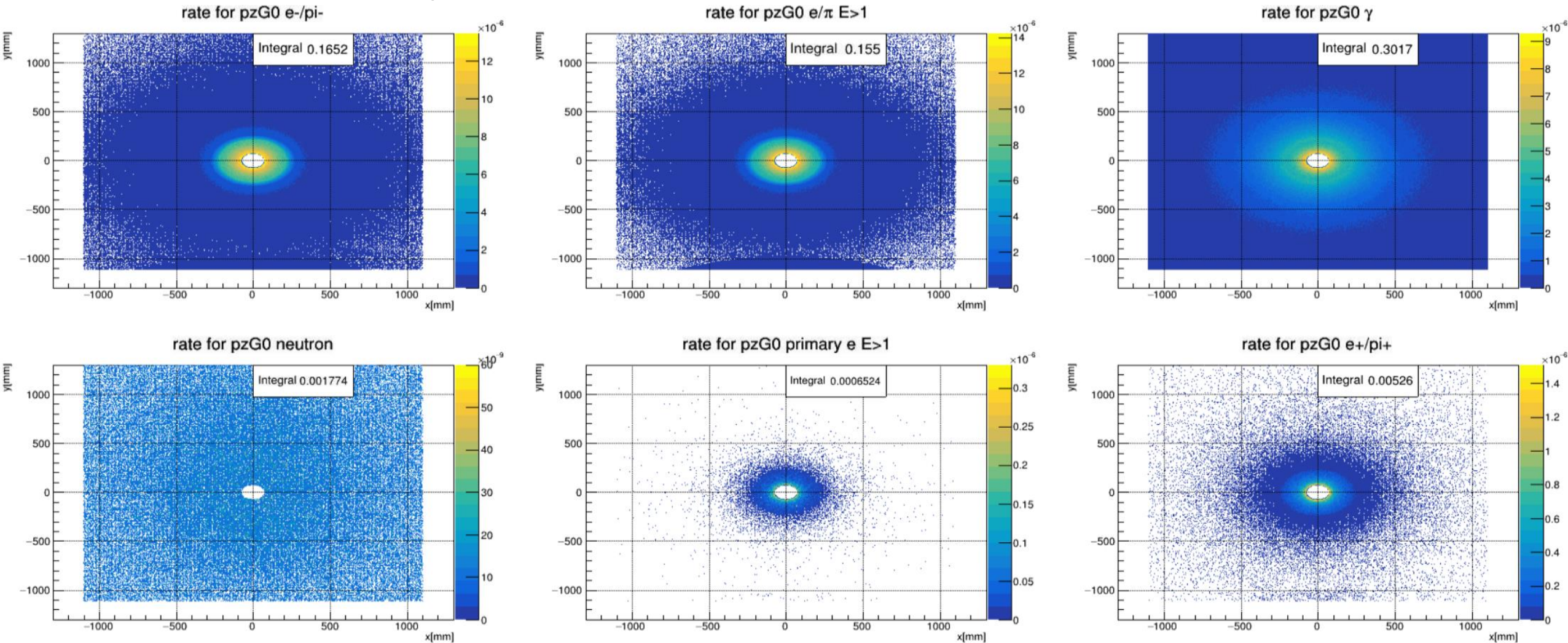

- The detector has an acceptance hole to not count particles that are not stopped



# Hits \* E/EOT with $p_Z > 0$ (before wall)

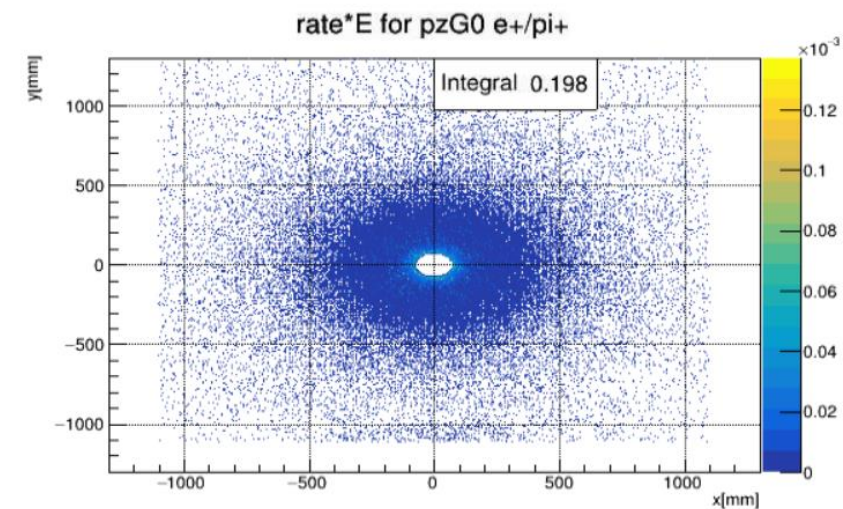
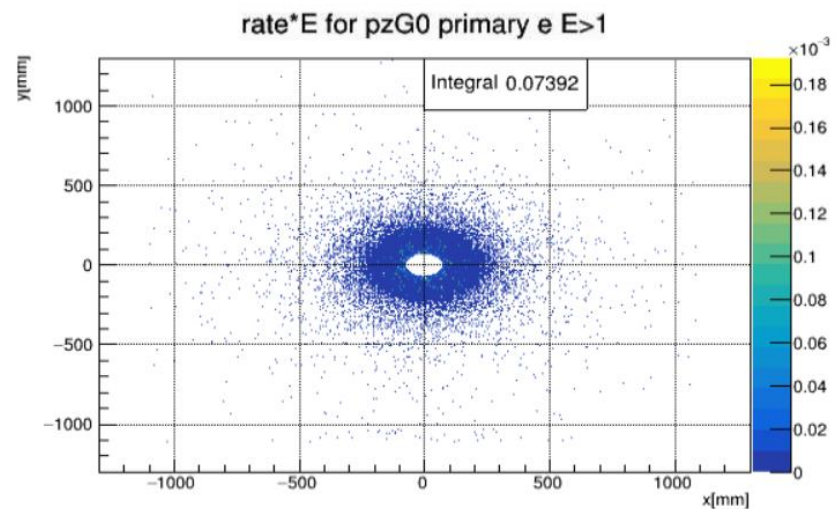
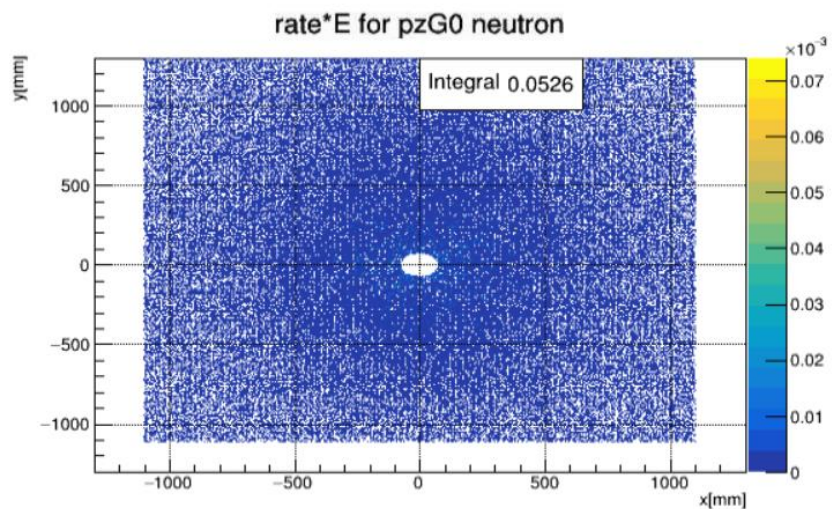
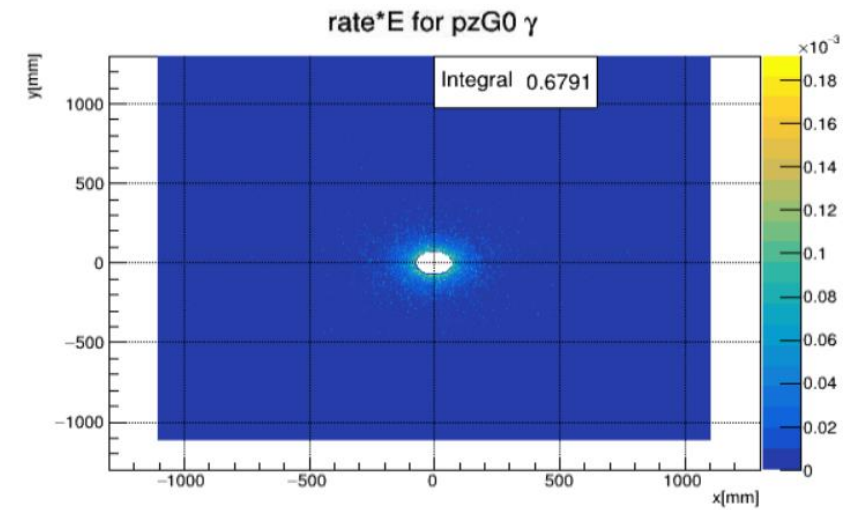
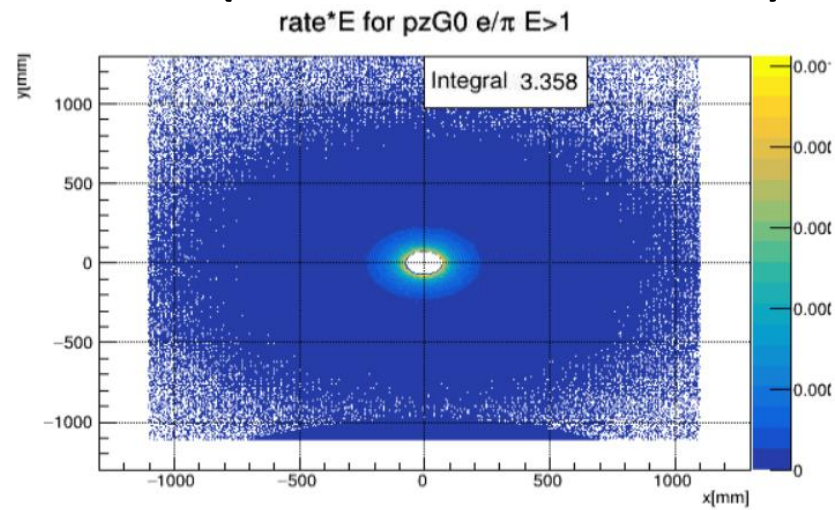
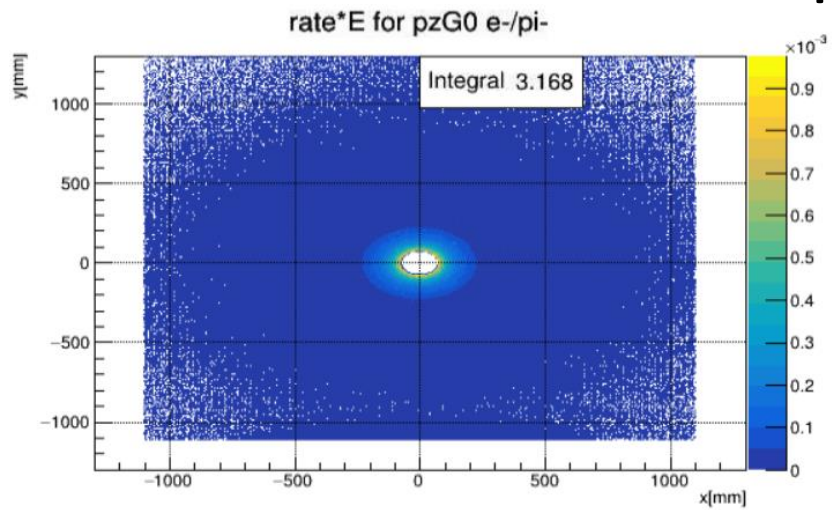

- As expected the high energy particles are forward peaked (perhaps it would allow us to make a different thickness wall radially to at least reduce mass)



# Hits \* E/EOT with $pZ > 0$ (after wall)

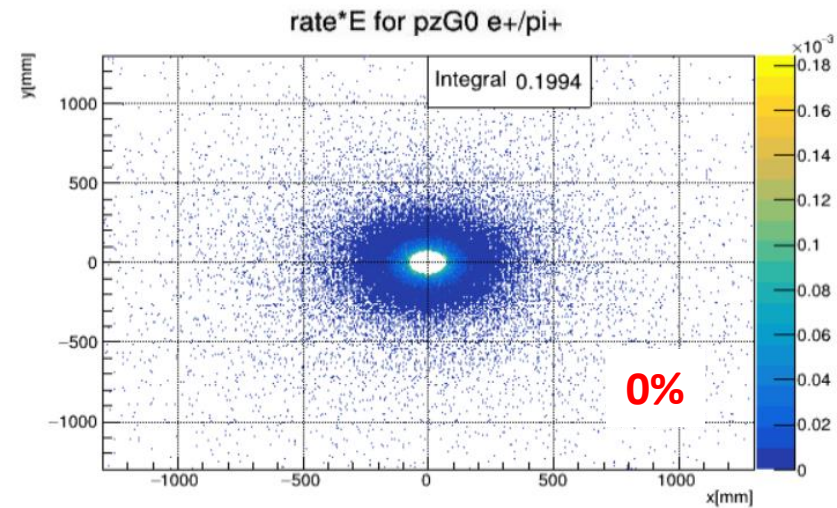
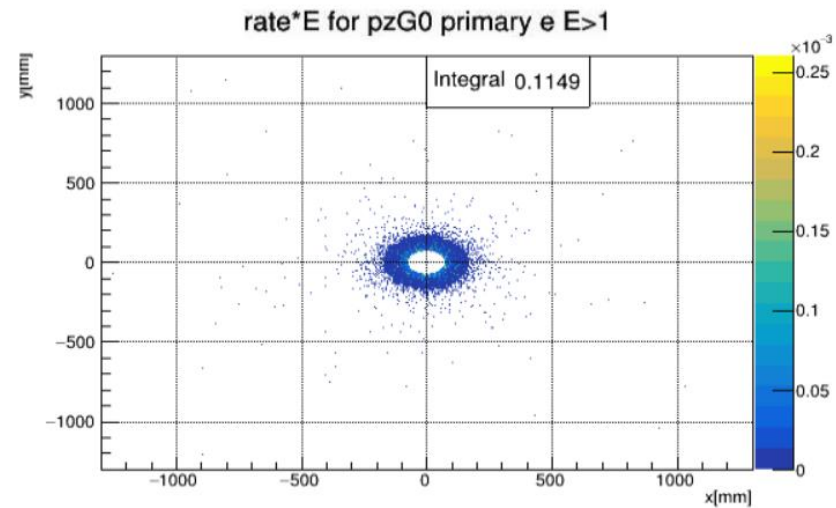
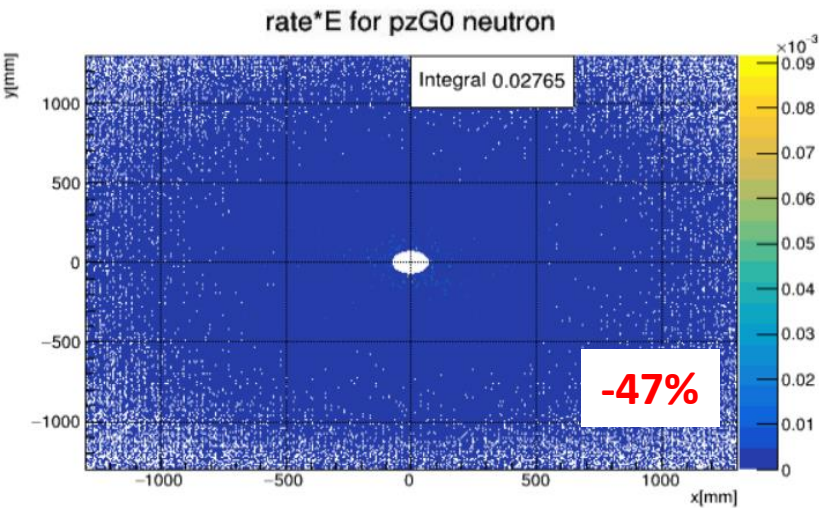
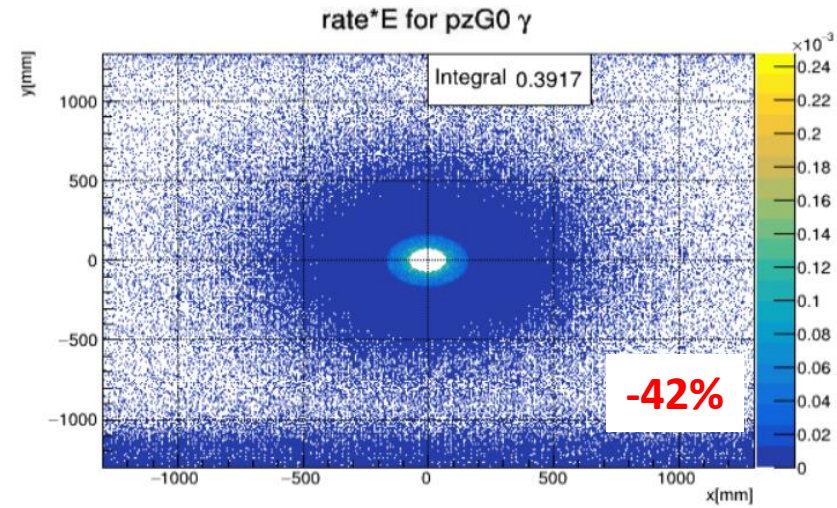
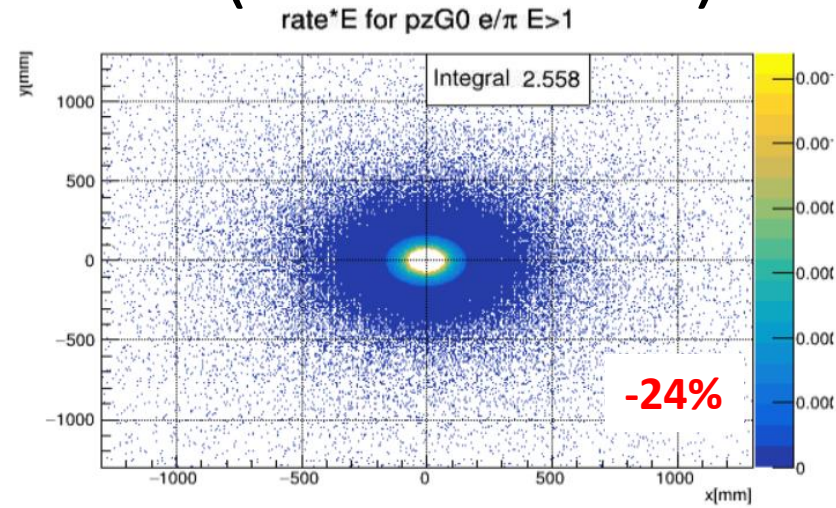
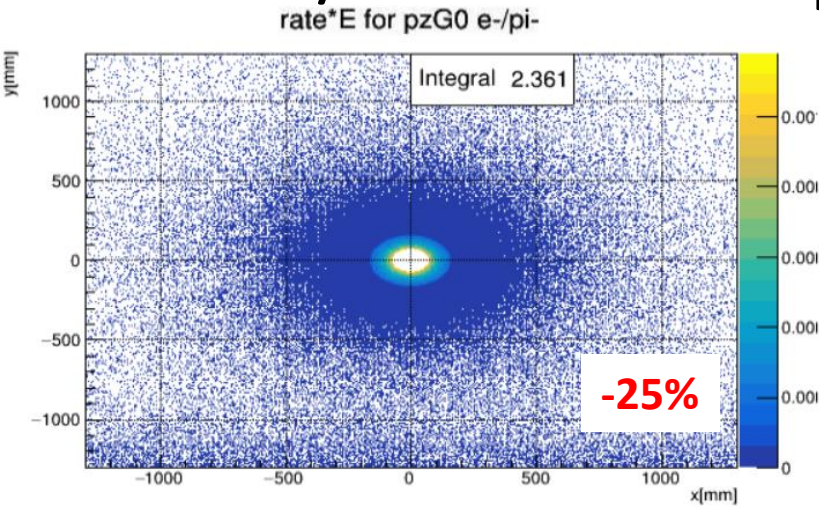

- The gammas and the neutrons seem to be most affected
  - Note that this detector is slightly larger (200mm on each side)



# Hits \* E/EOT with $p_Z > 0$ (before wall) Pb wall

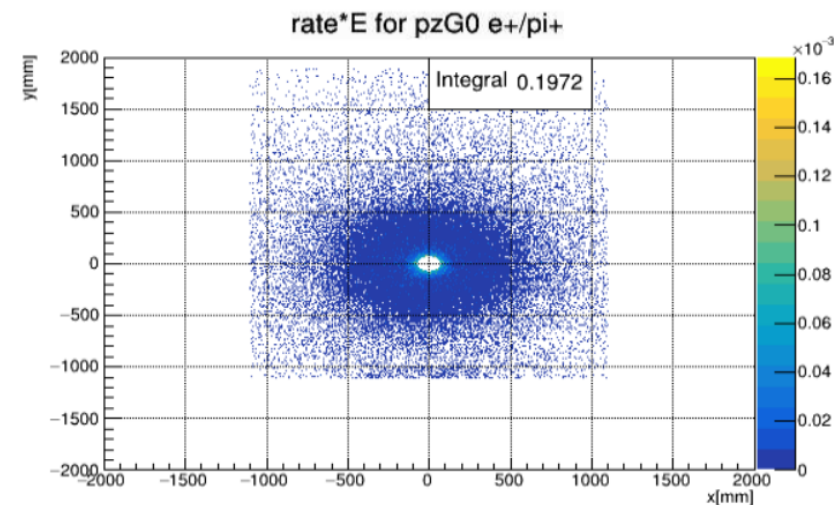
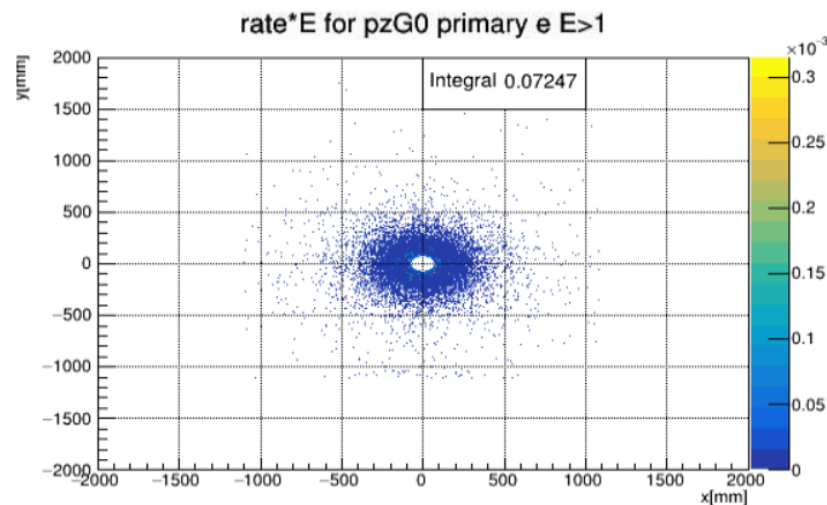
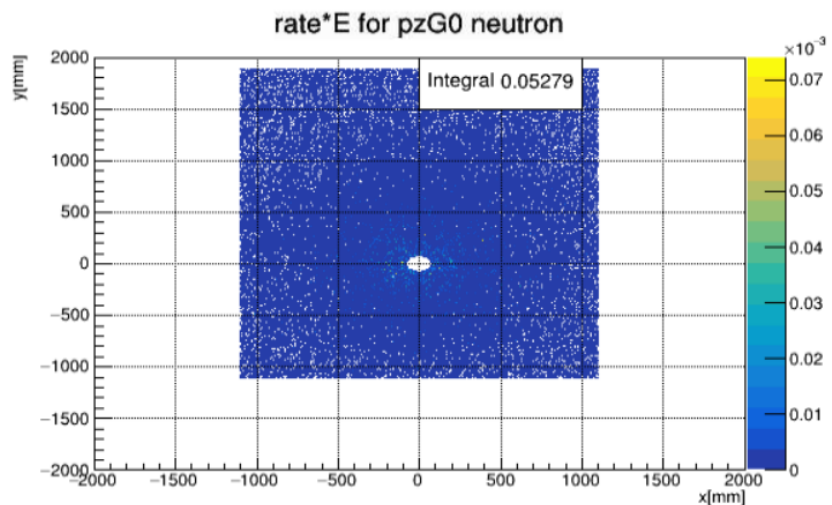
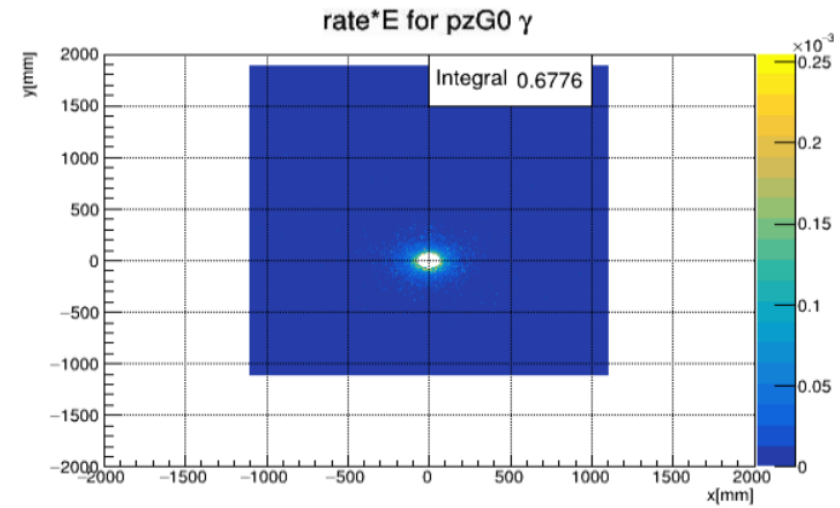
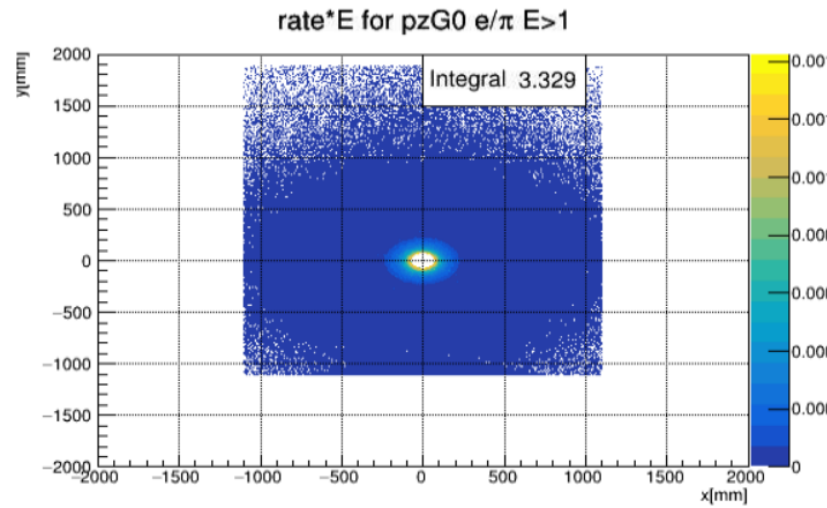
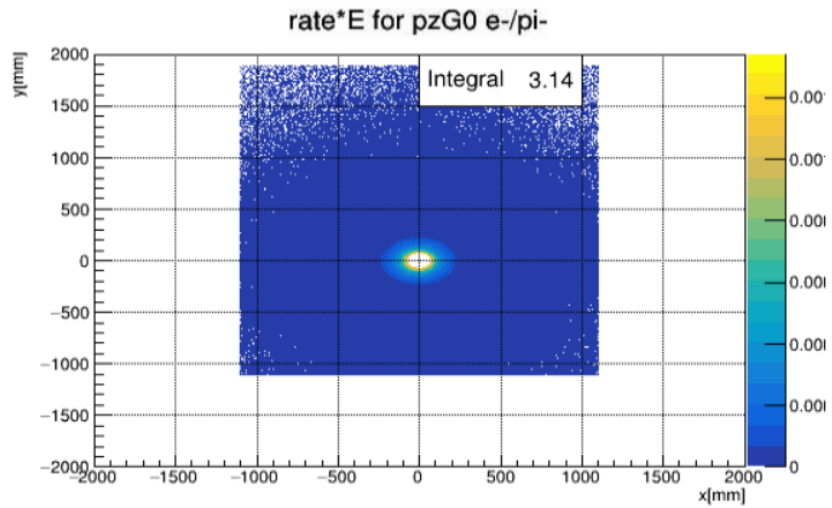

- The gammas and the neutrons seem to be most affected
  - Note that this detector is slightly larger (200mm on each side)

# Hits/EOT with $pZ > 0$ (before wall) Pb wall

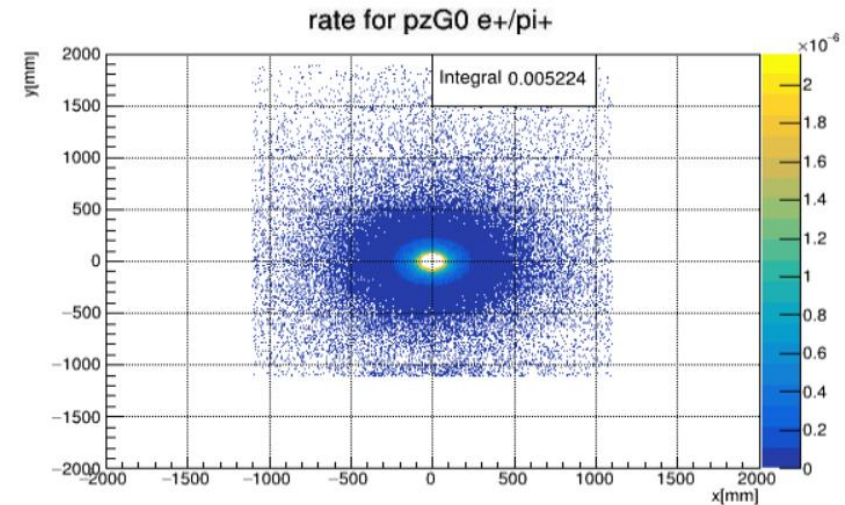
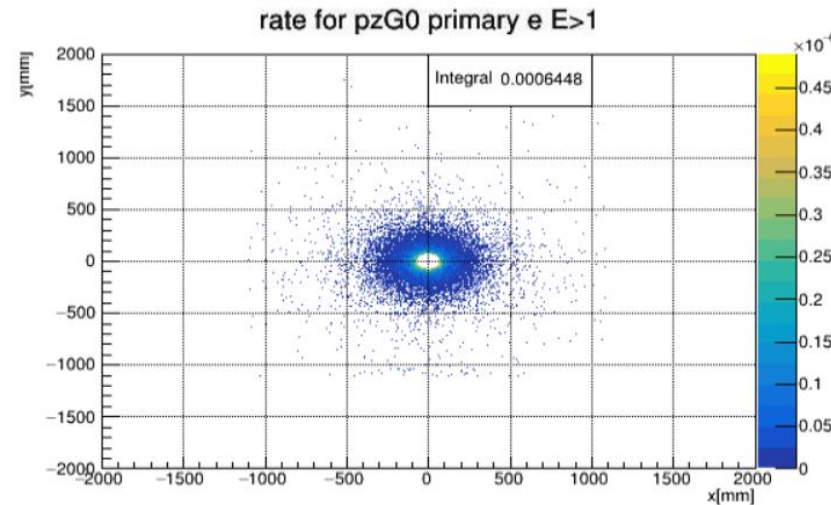
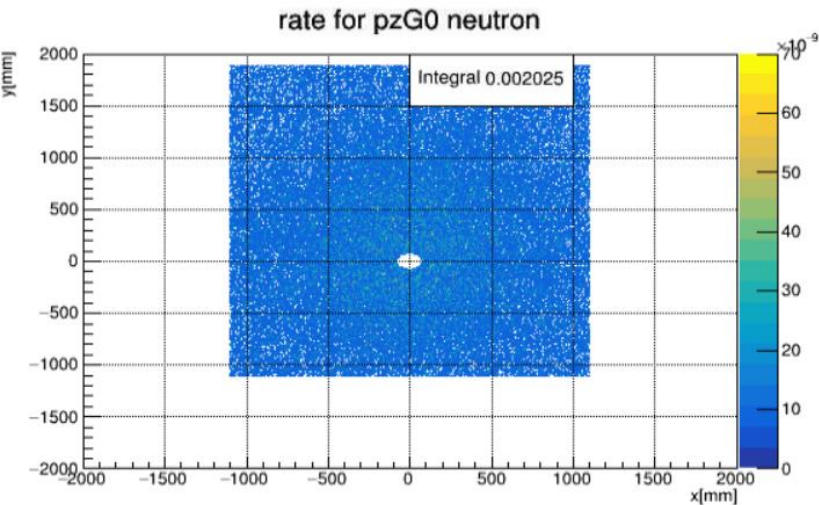
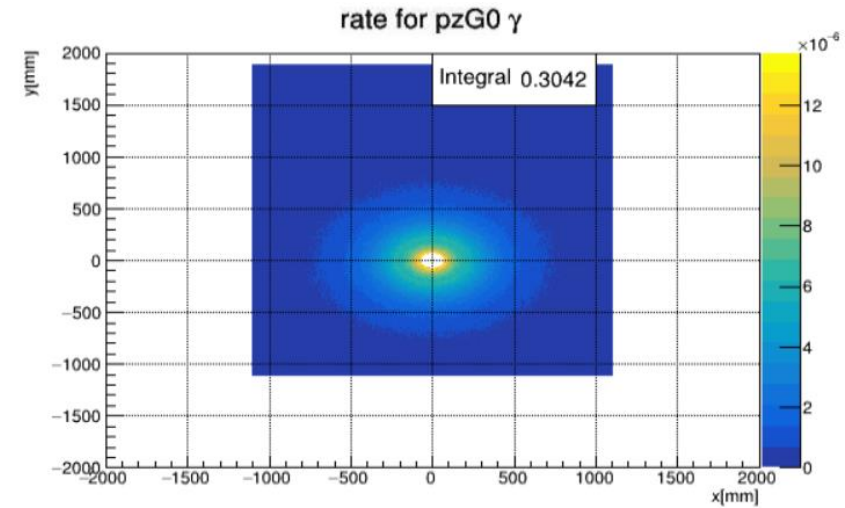
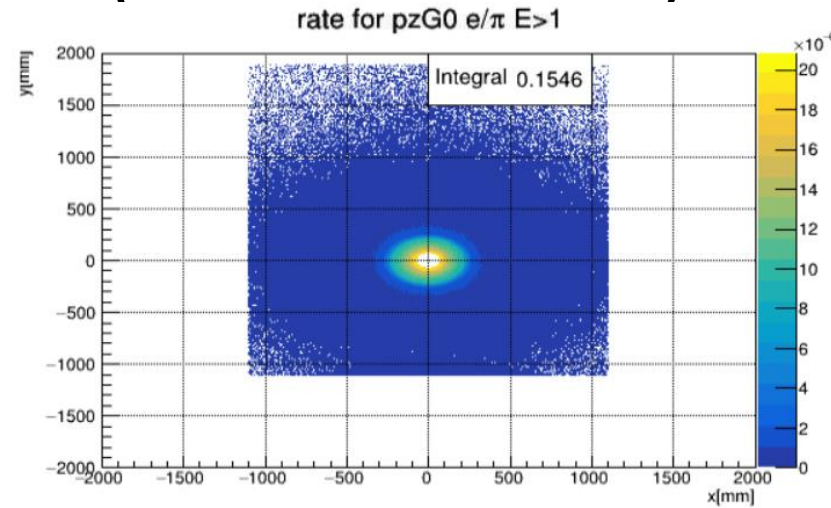
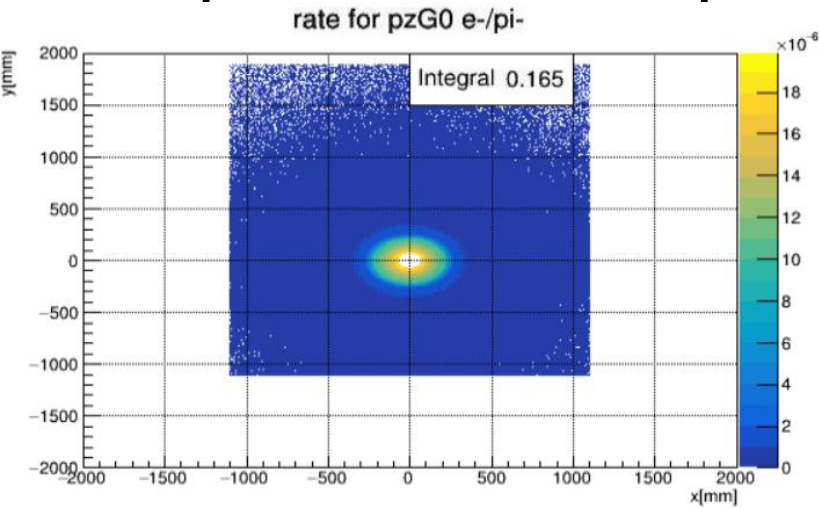

- The gammas and the neutrons seem to be most affected
  - Note that this detector is slightly larger (200mm on each side)



# Hits \* E/EOT with $pZ > 0$ (after wall) Pb wall

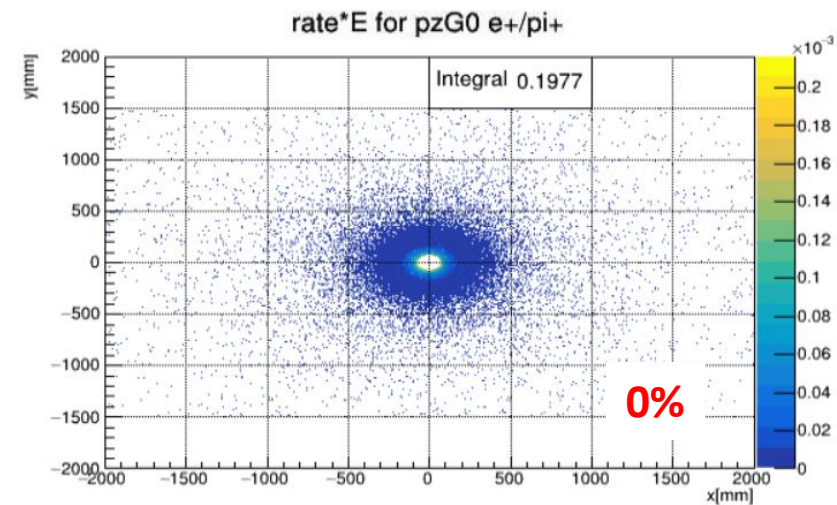
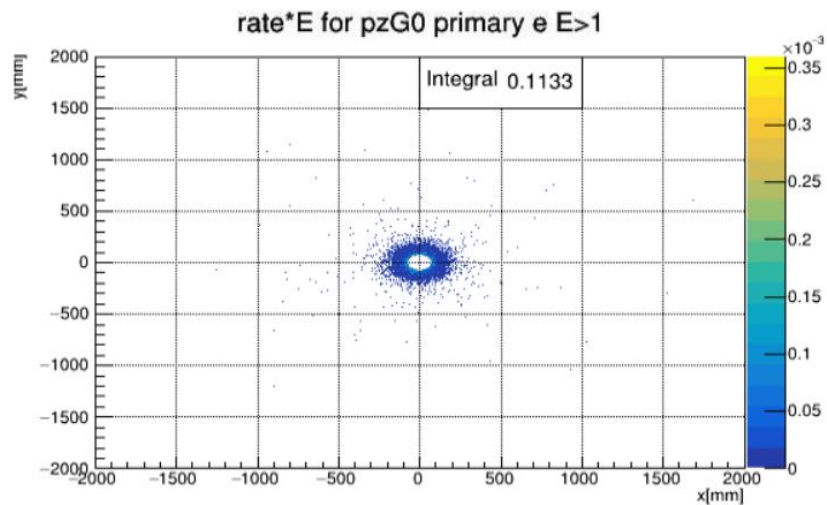
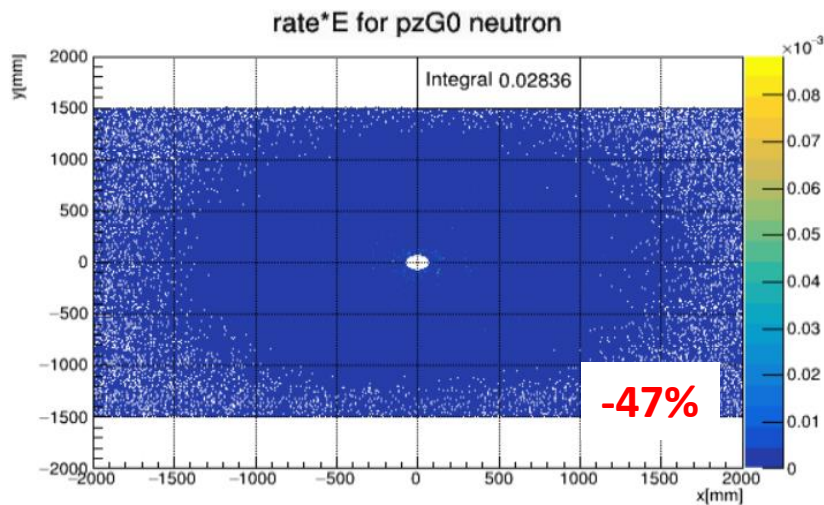
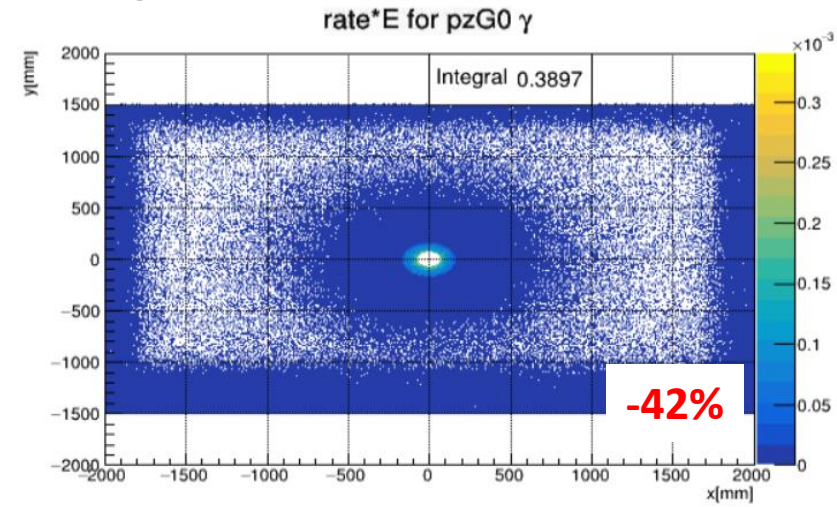
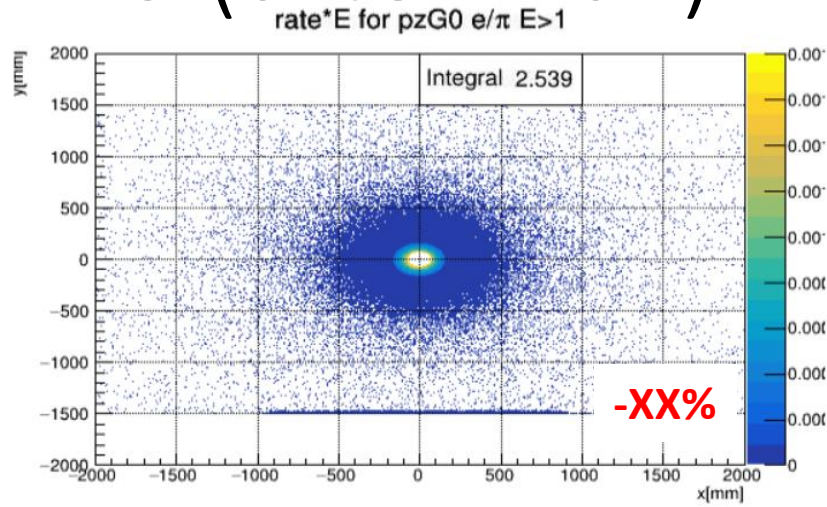
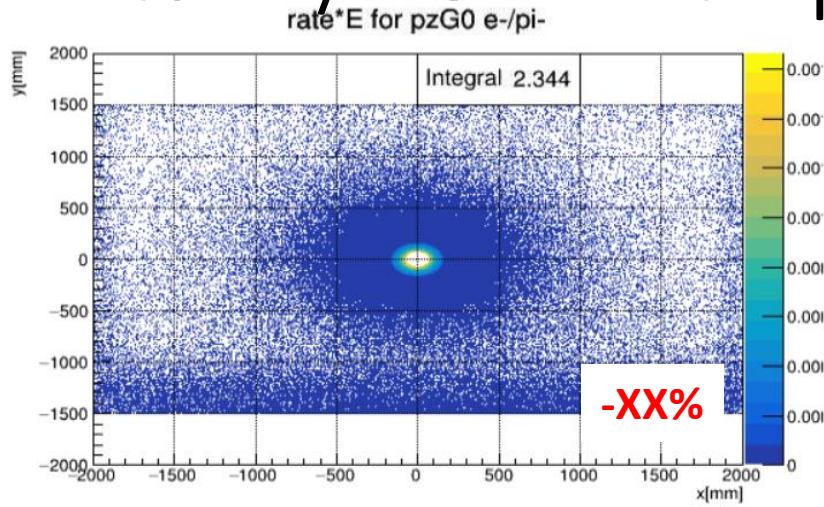

- The gammas and the neutrons seem to be most affected
  - Note that this detector is slightly larger (200mm on each side)



# Hits \* E/EOT with $p_Z > 0$ (before wall) – concrete wall

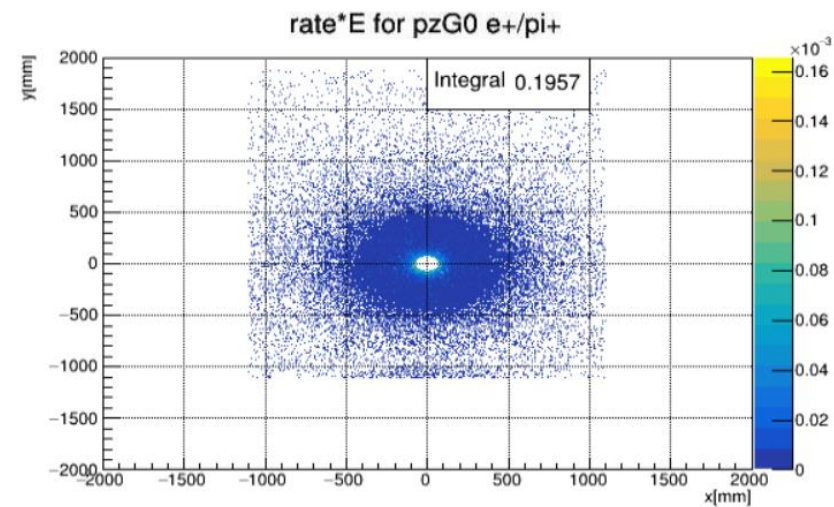
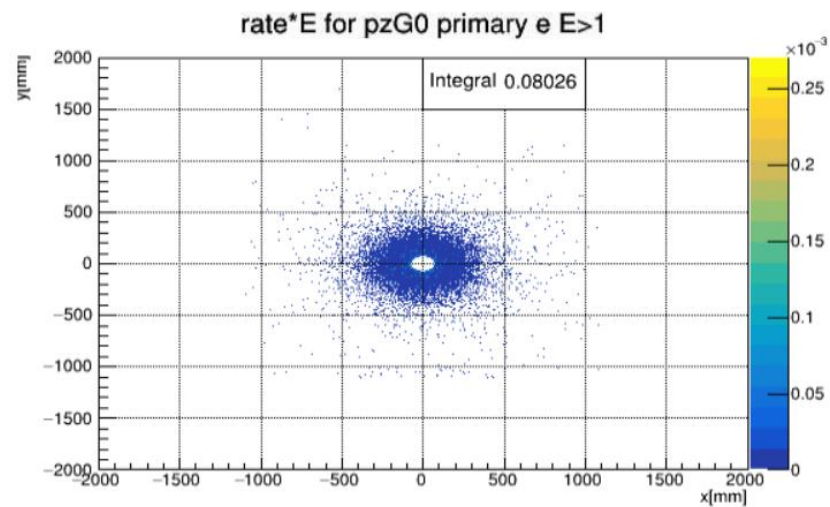
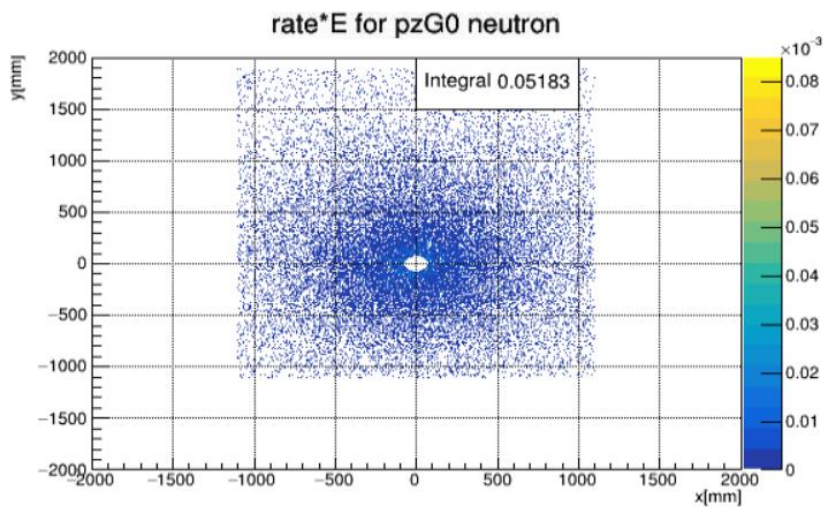
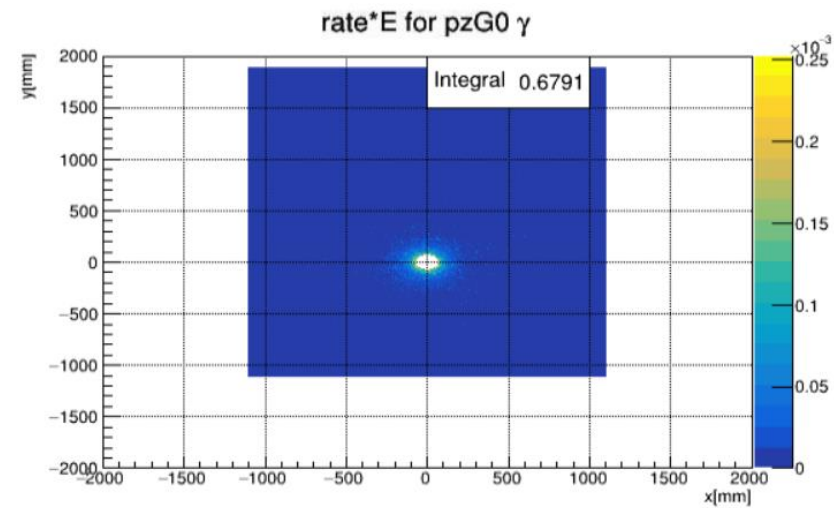
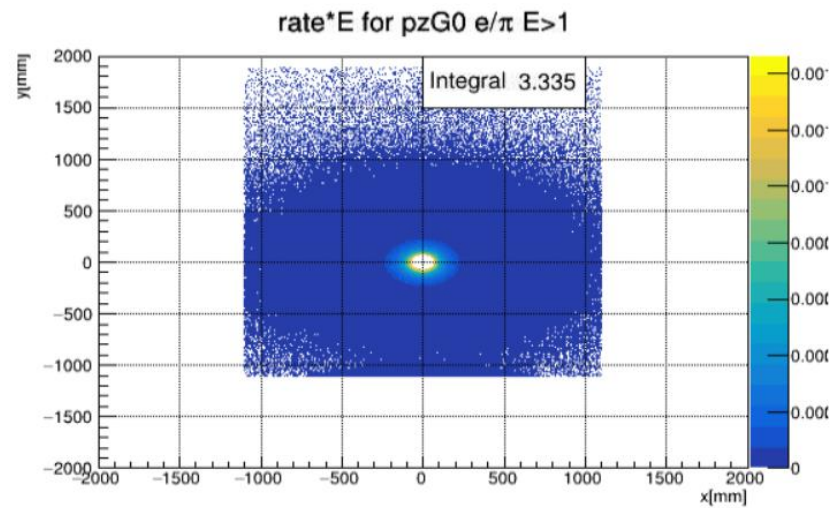
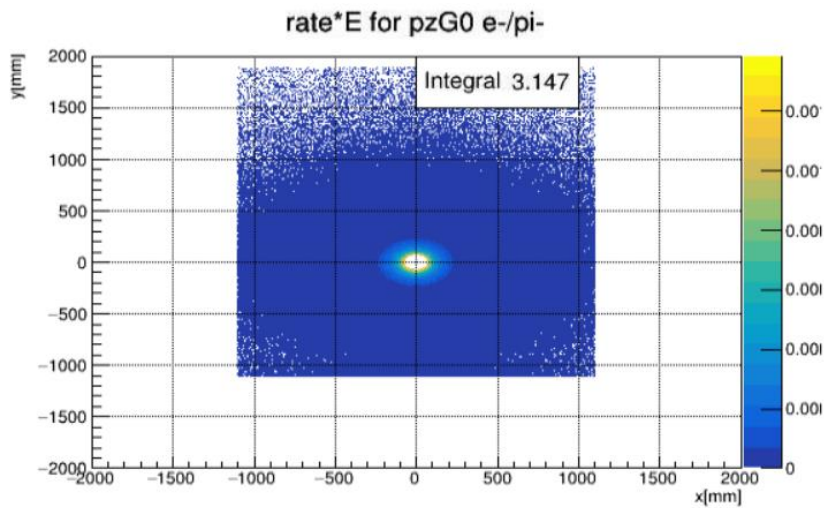

- The gammas and the neutrons seem to be most affected
  - Note that this detector is slightly larger (200mm on each side)



# Hits/EOT with $pZ > 0$ (before wall) – concrete wall

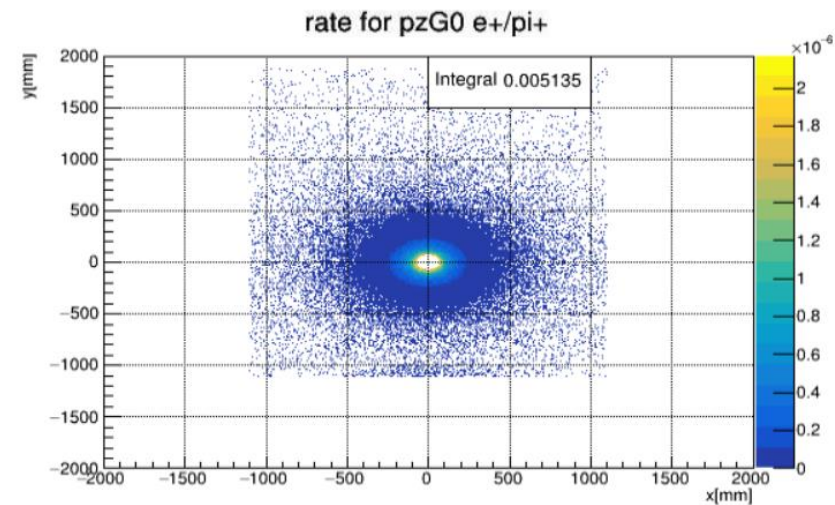
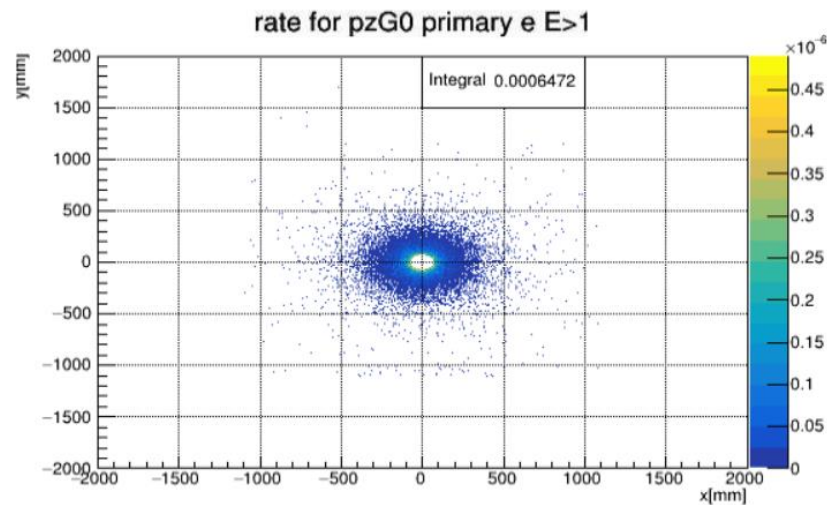
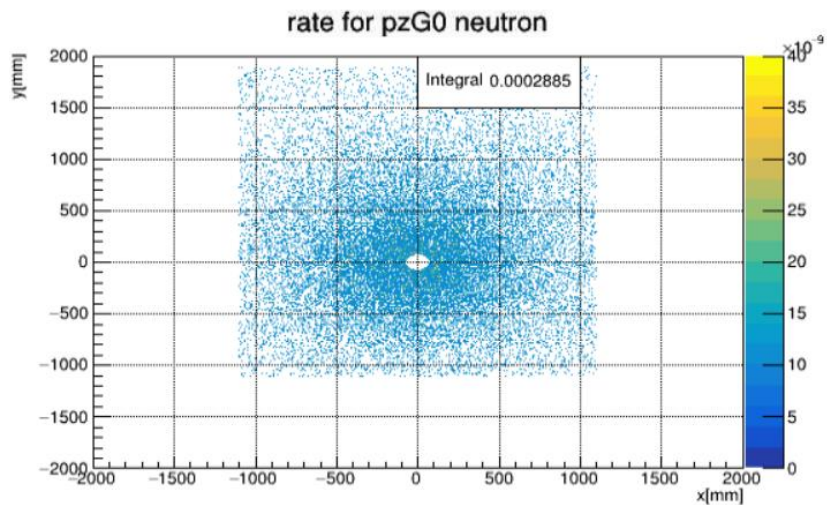
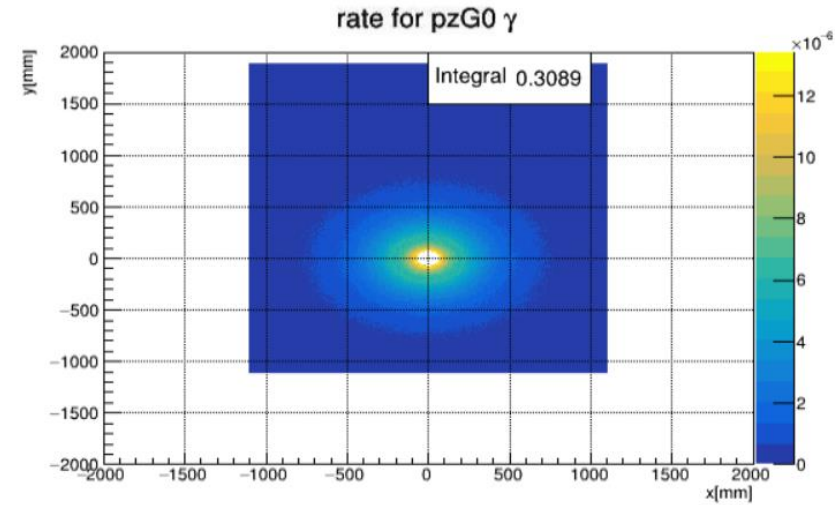
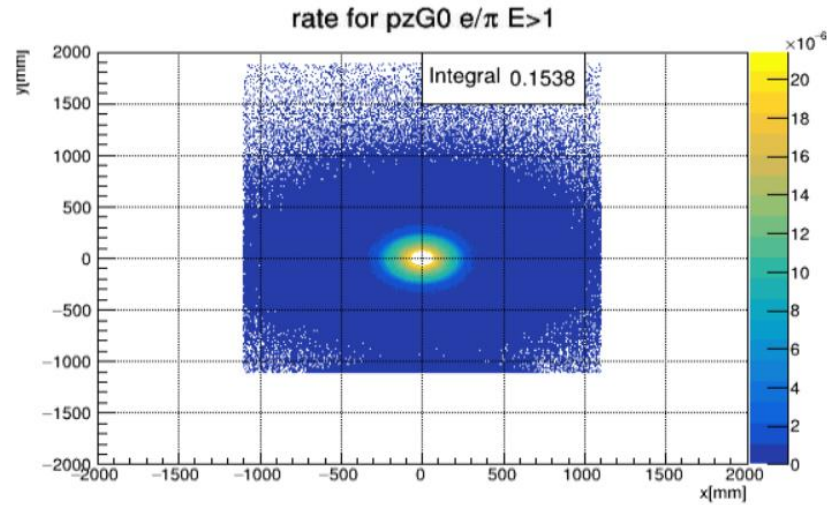
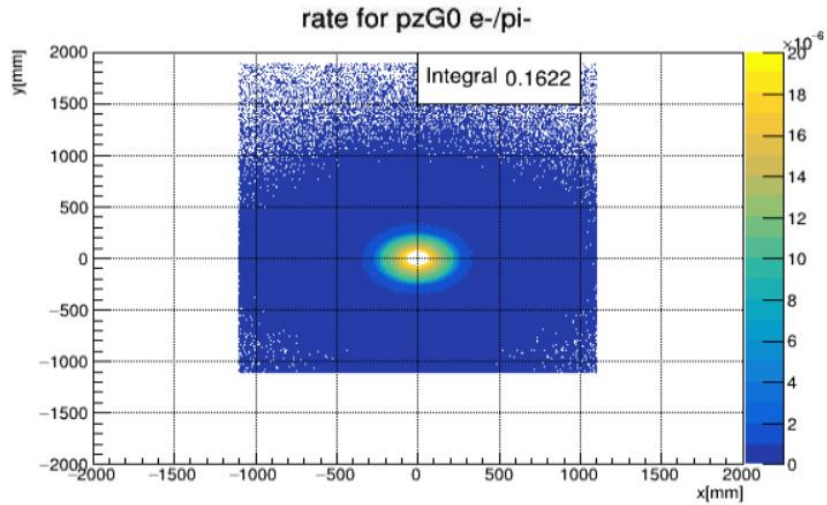

- The gammas and the neutrons seem to be most affected
  - Note that this detector is slightly larger (200mm on each side)

# Hits \* E/EOT with $pZ > 0$ (after wall) – concrete wall

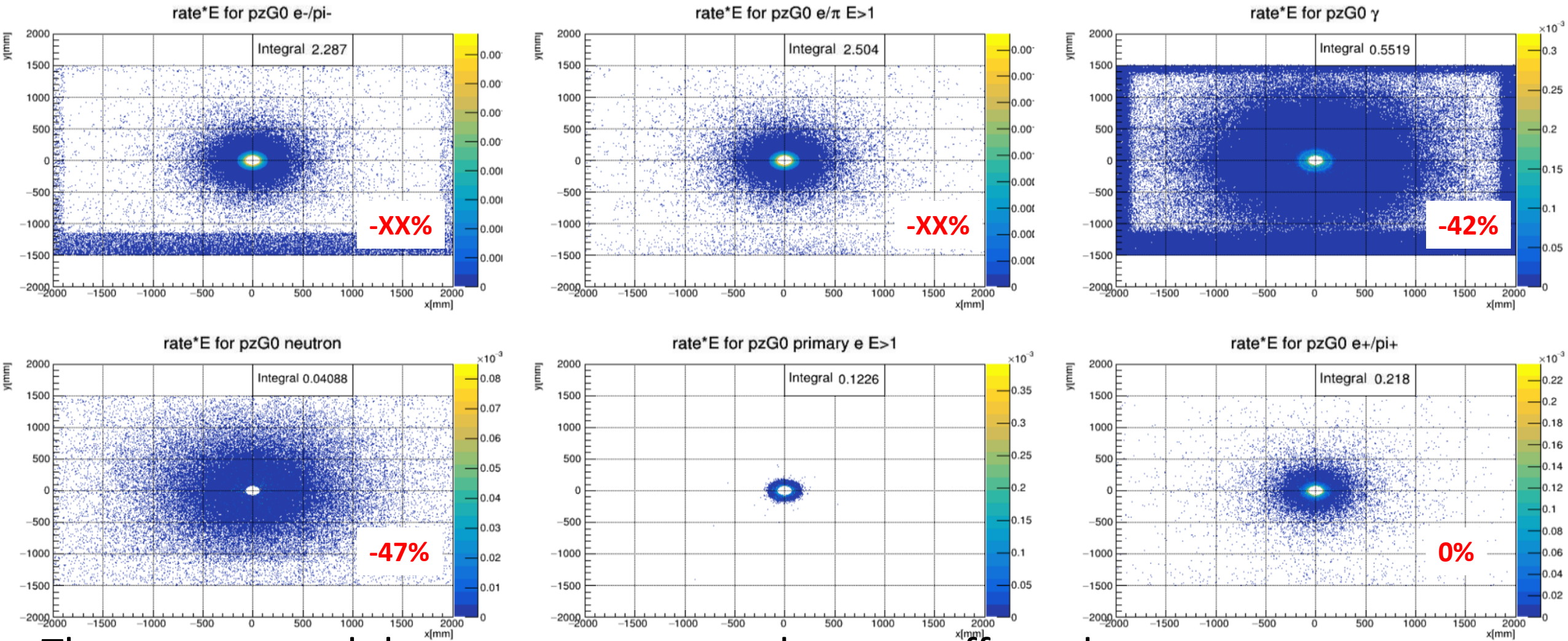

- The gammas and the neutrons seem to be most affected
  - Note that this detector is slightly larger (200mm on each side)



asdf

- asdf

# Hits/EOT with $pZ > 0$ (after tgt bunker) – Pb wall

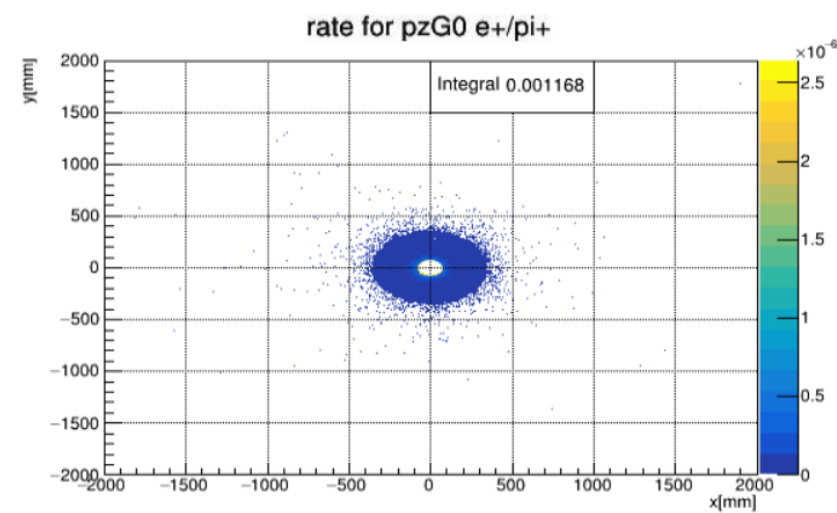
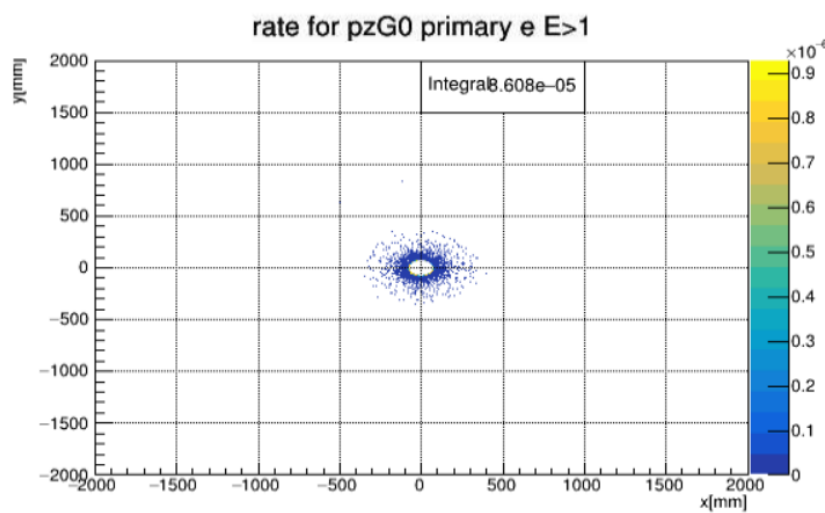
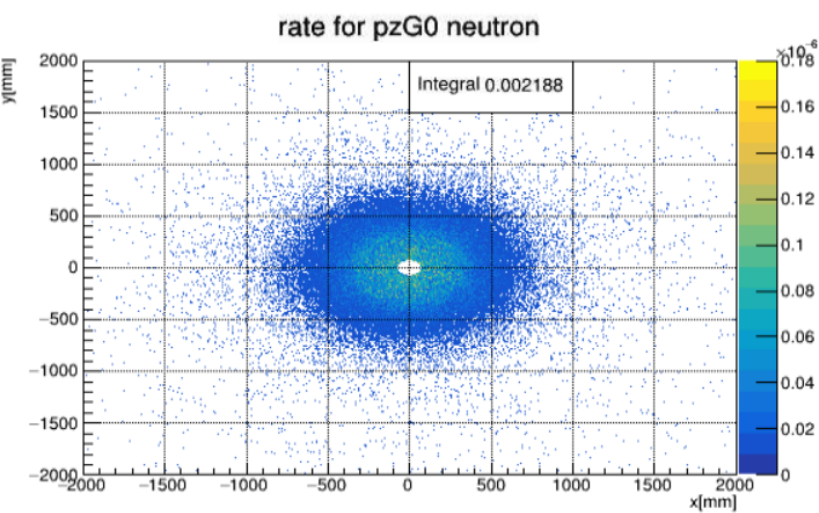
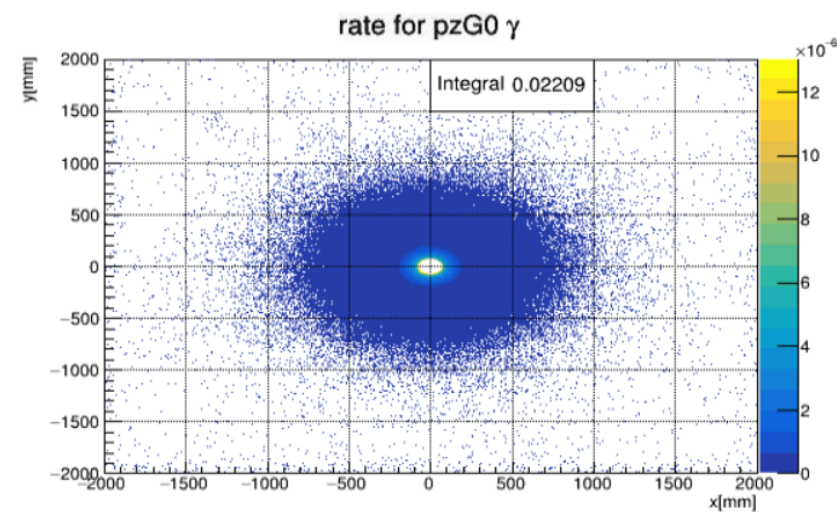
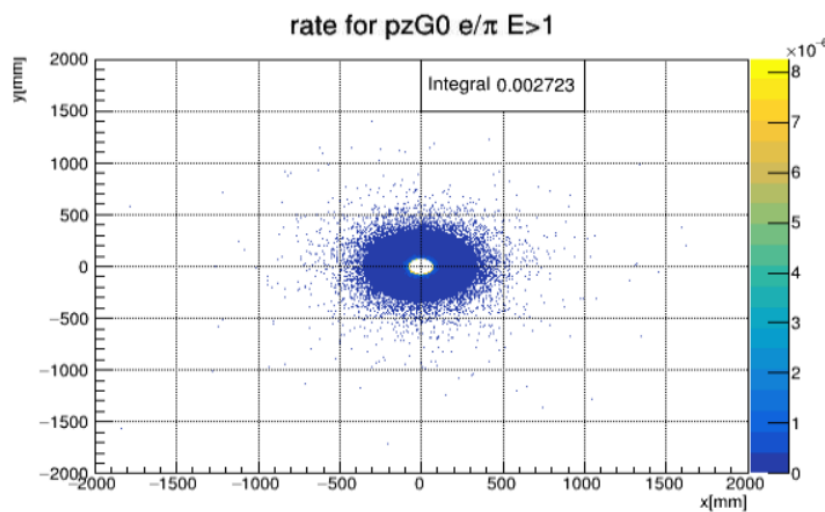
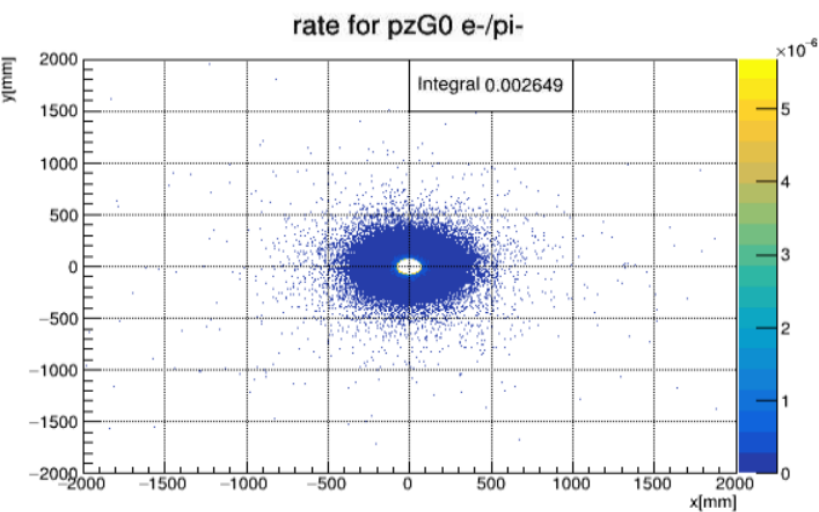

- asdt

# Hits/EOT with $pZ > 0$ (after tgt bunker) – concrete wall

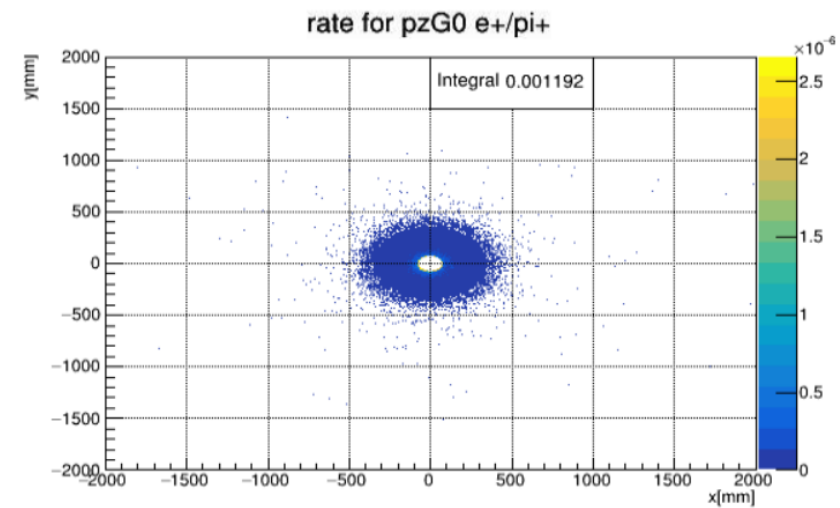
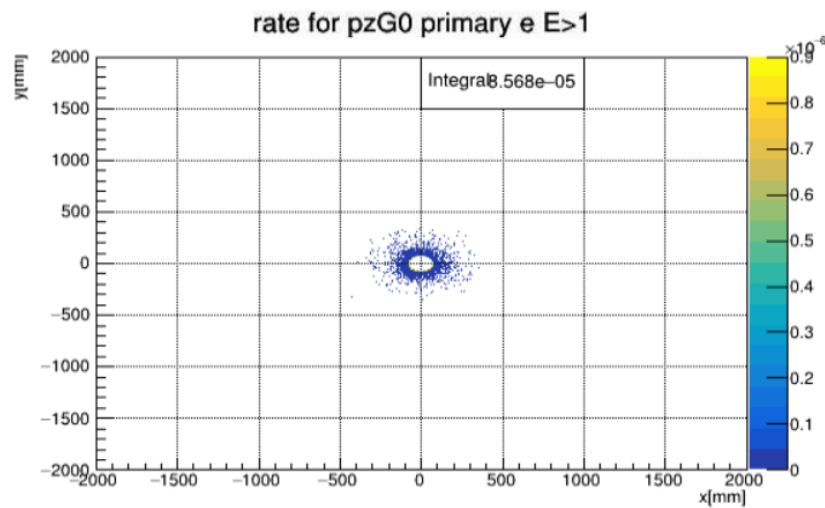
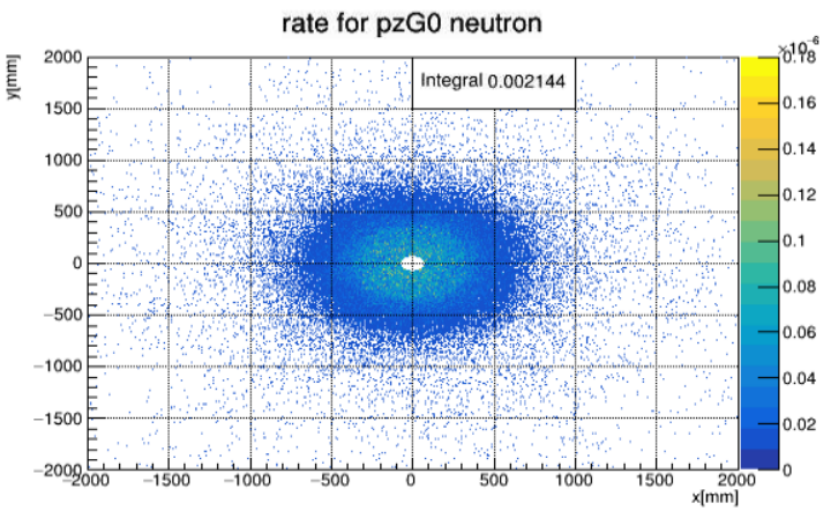
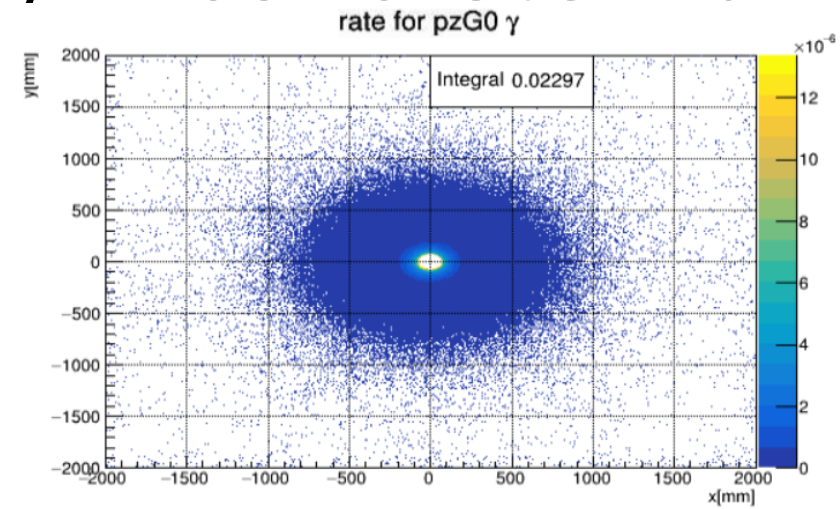
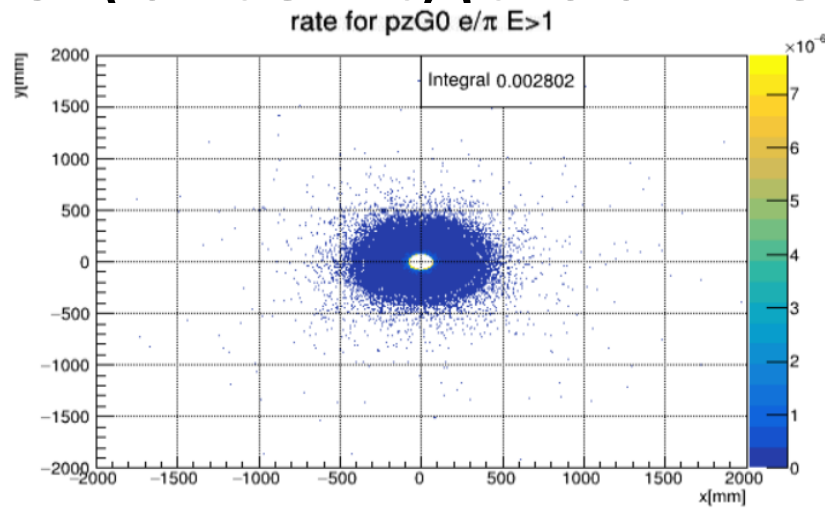
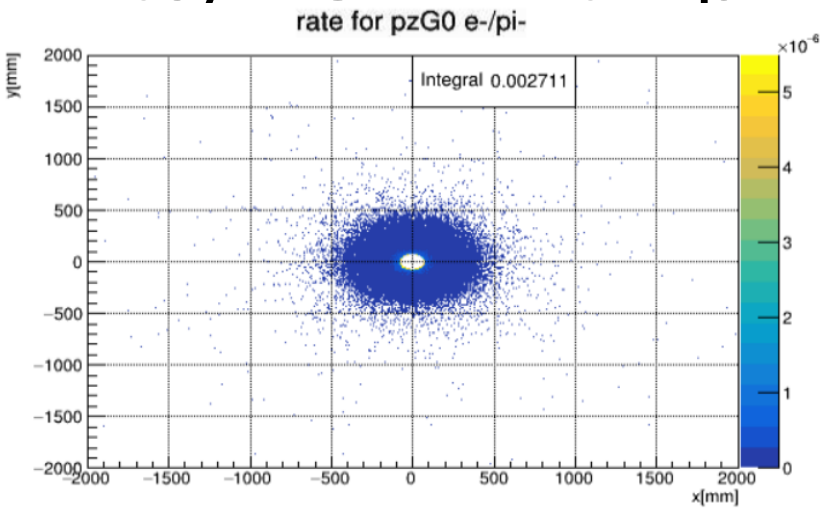

• asdf



# Hits \* E/EOT with $p_Z > 0$ (after tgt bunker) – Pb wall

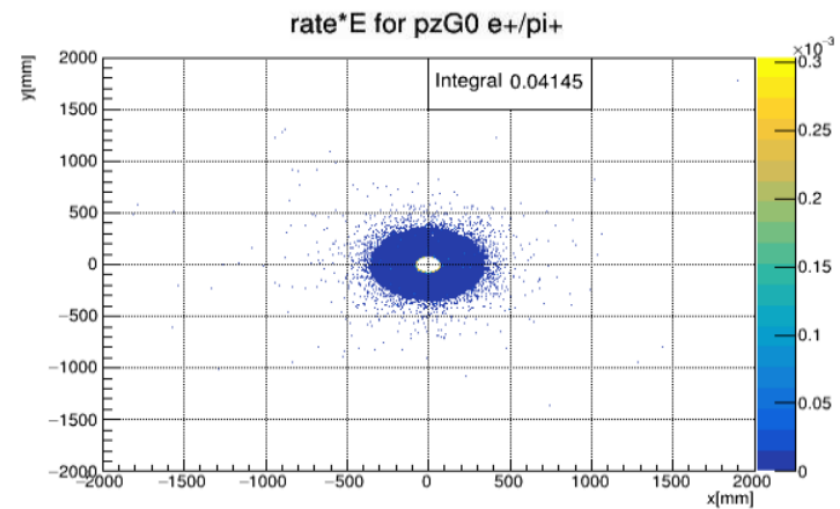
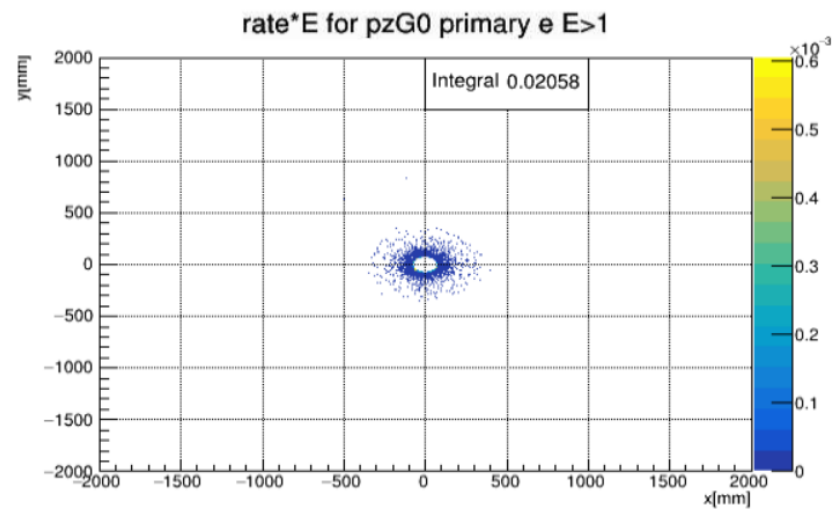
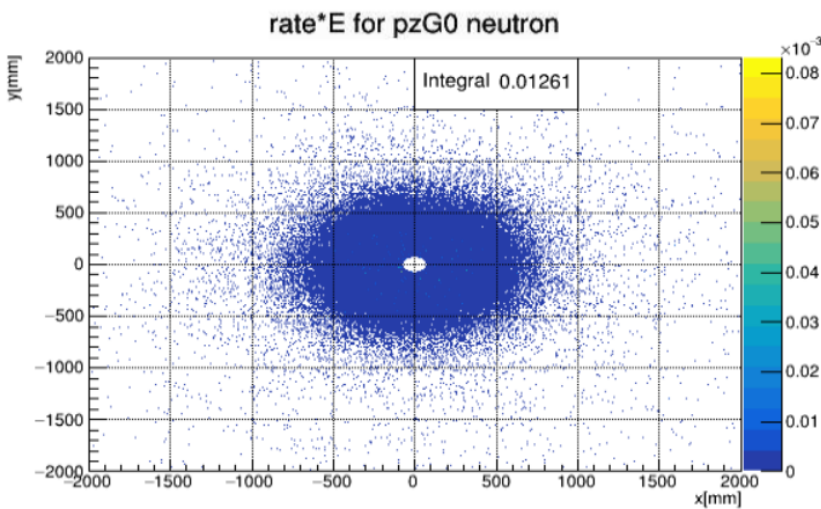
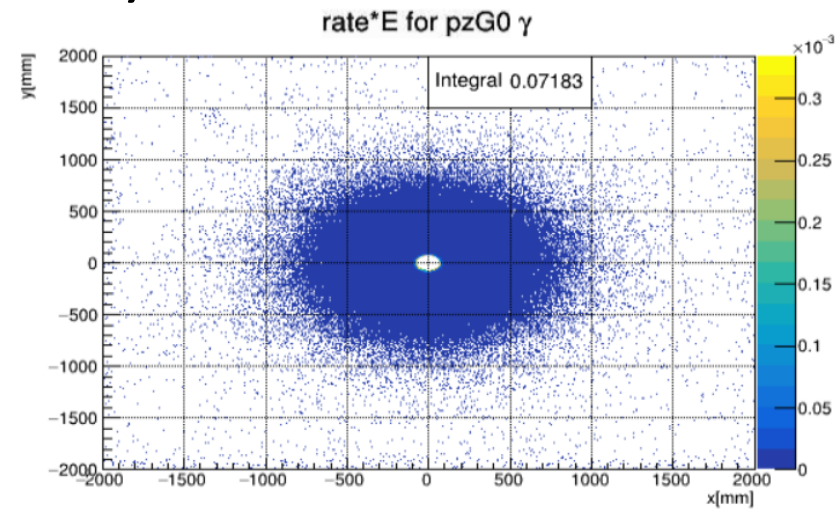
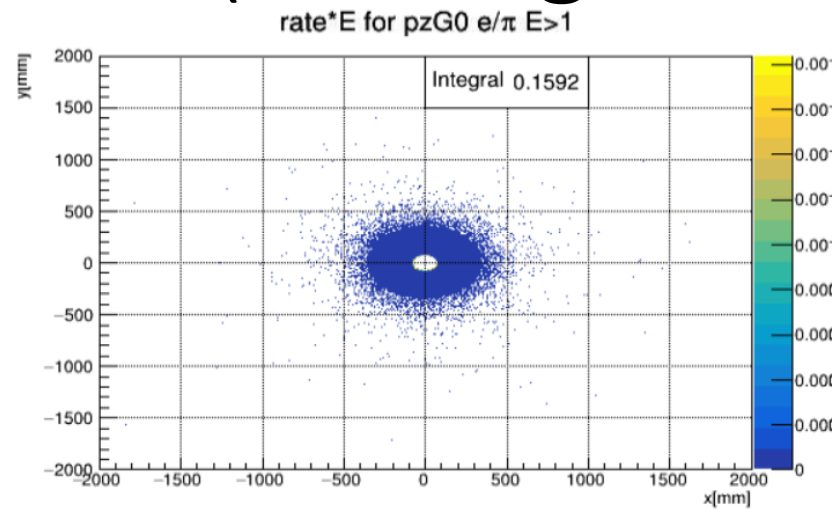
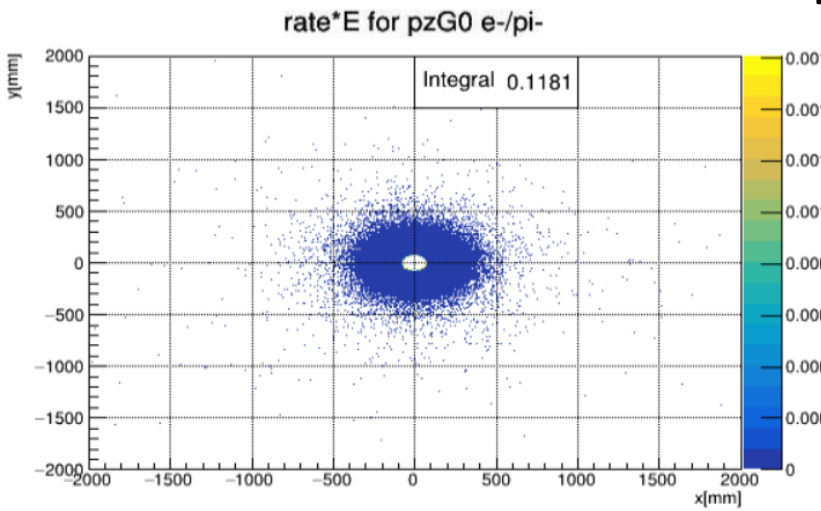

• asdf

# Hits \* E/EOT with pZ > 0 (after tgt bunker) – concrete wall

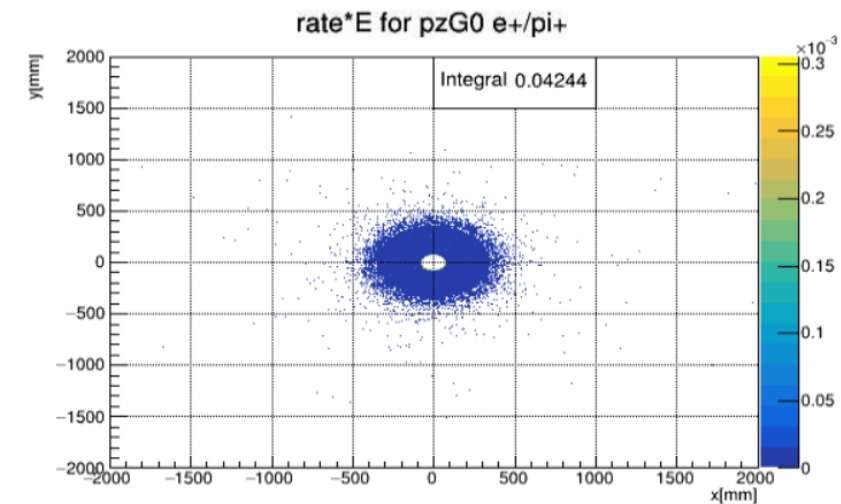
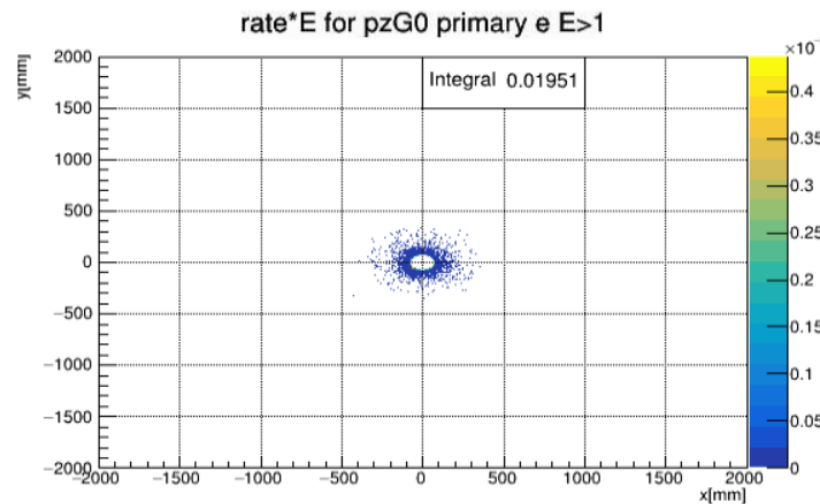
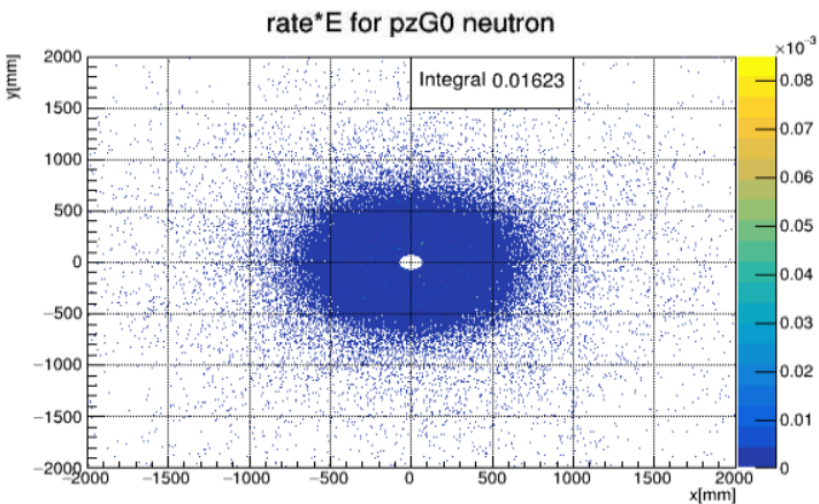
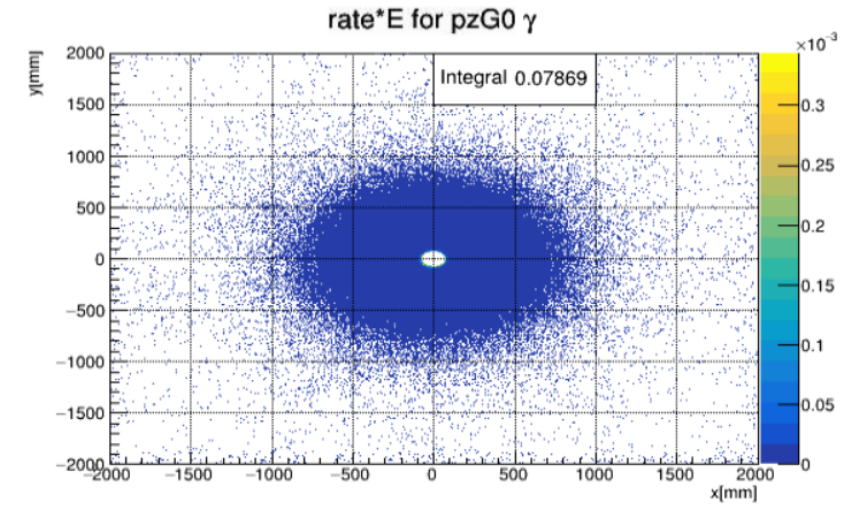
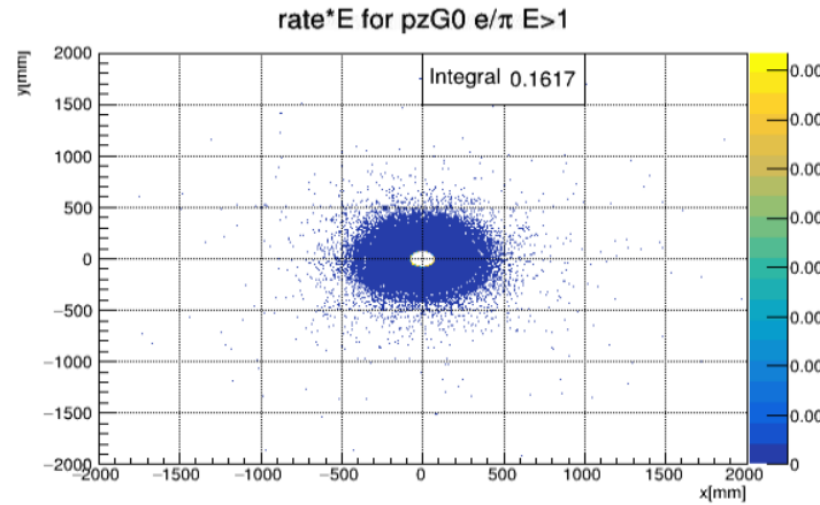
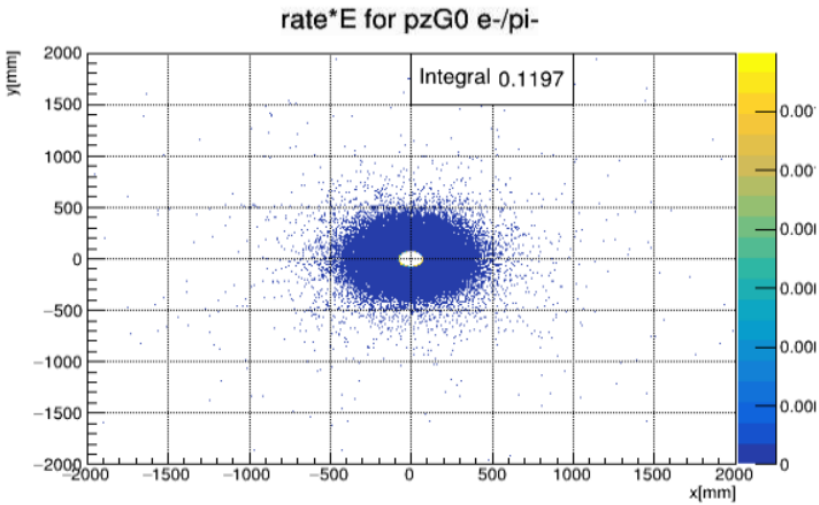

• asdf



# Table with integrals

	Hits				Hits * E		
	Lead	Concrete	(C-P)/P		Lead	Concrete	(C-P)/P
e-	2.65E-03	0.002711	2%		1.18E-01	0.1197	1%
e E>1	2.72E-03	2.80E-03	3%		1.59E-01	1.62E-01	2%
g	2.21E-02	2.30E-02	4%		7.18E-02	7.87E-02	10%
n	2.19E-02	2.14E-03	-90%		1.26E-02	1.62E-02	29%
primary E>1	8.61E-05	8.57E-05	0%		2.06E-02	1.95E-02	-5%
e+	1.12E-03	1.19E-03	7%		4.15E-02	4.24E-02	2%

- The simulations indicate that the Pb wall is producing quite a large number of low energy neutrons which we don't see when we replace it with more concrete
  - This could lead to increases at the MD region and the hall wall (should we include this in the boundary dose estimate?)
- For EM it seems that we have marginal increases if we just replace the Pb with concrete

# Todos

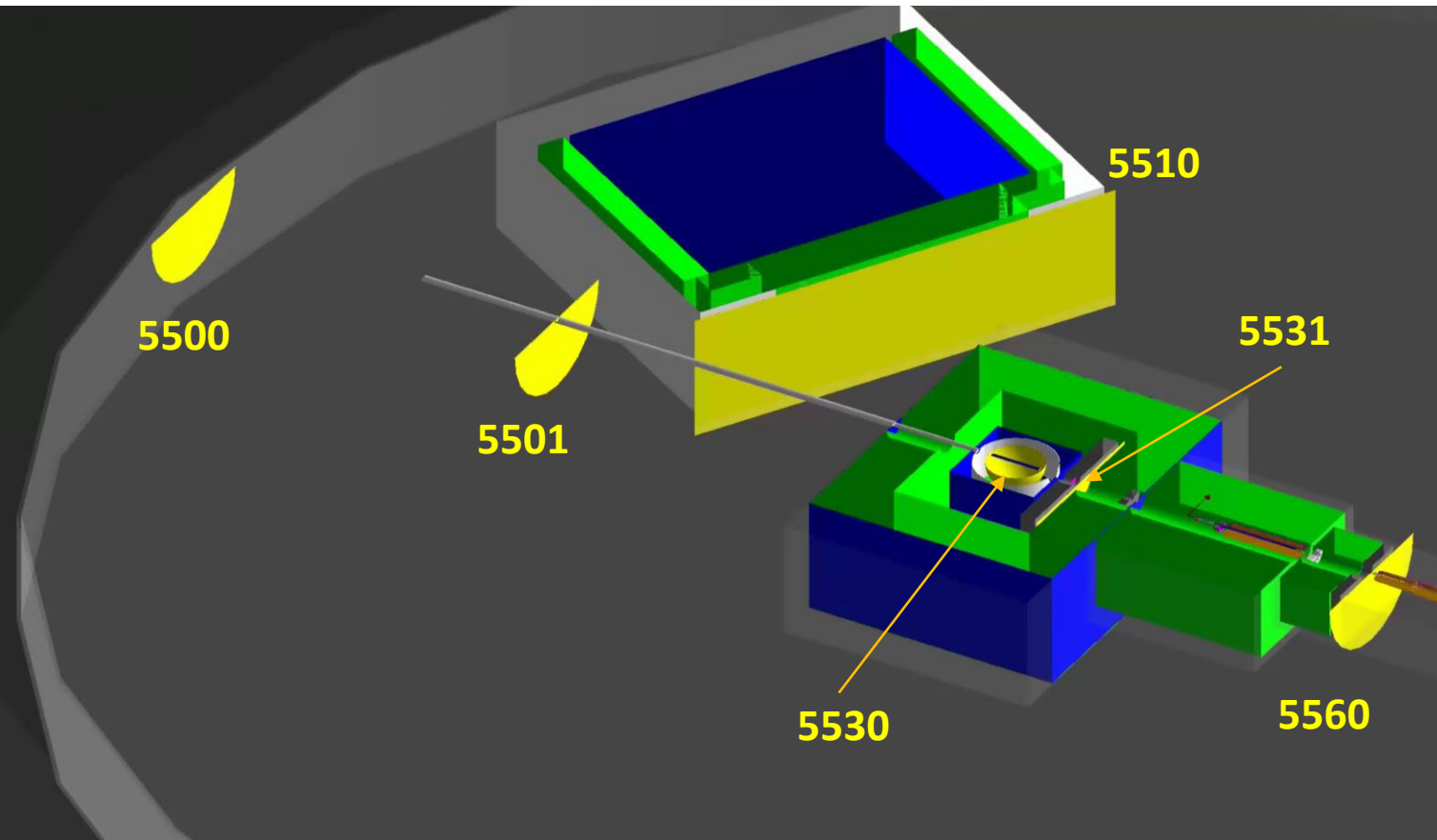

- Evaluate the high energy neutrons on the roof of the bunker and see the effect of the 2m hole
  - Naz and Sakib are working on a simulation that has:
    - No US wall
    - Replaces the lead with simple concrete
    - 2m hole on the top of the bunker
- Look at the spectra and number of hits at the front of the SBS bunker and the “Moller” polarimeter and entrance in the hall
- Look at the side of the bunker and evaluate what kind of reduction we have and if we can reduce the thickness

# Backup

# Current configuration around target

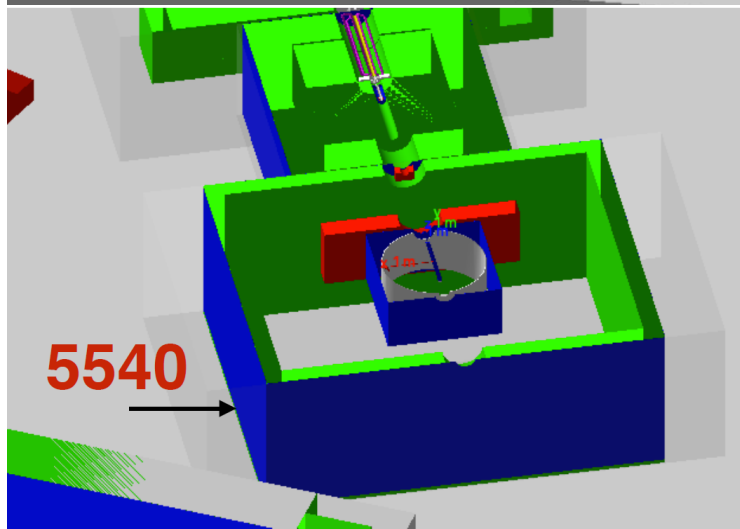
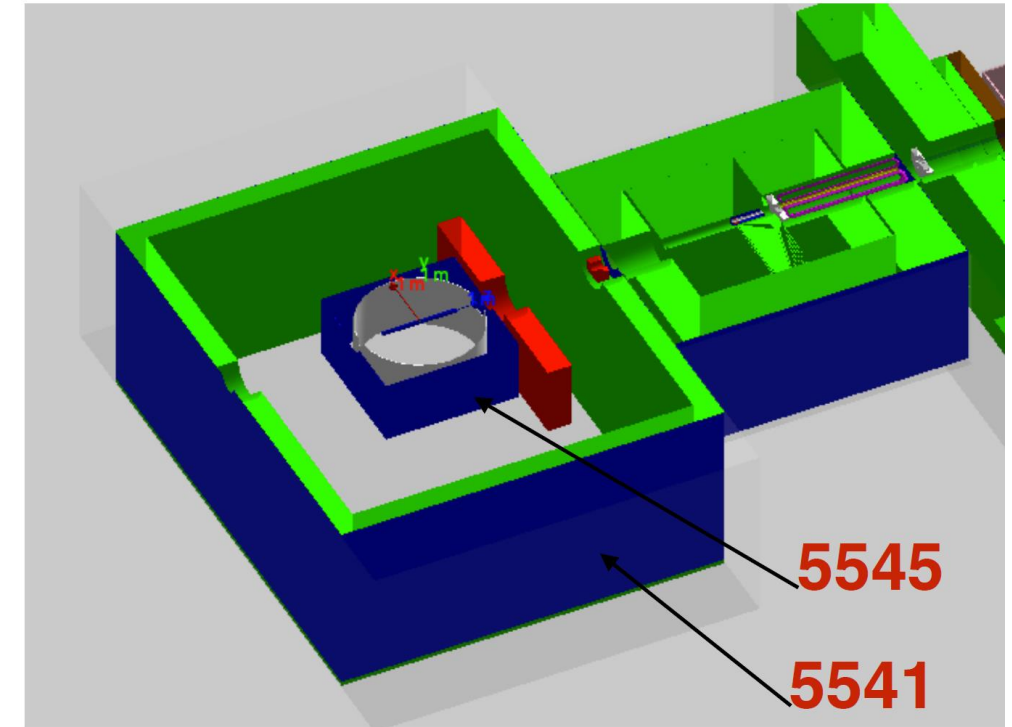
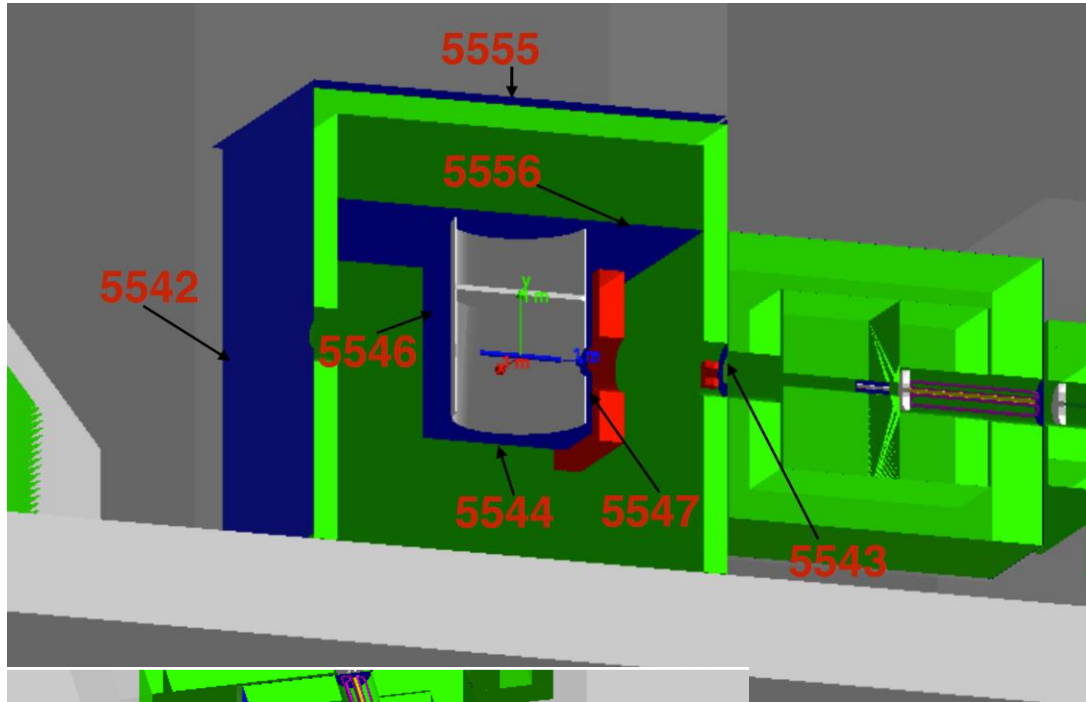

- Flat detectors around the target and outside of the bunker
  - Leave these in place for now, but add additional detector
  - Has holes for primary beam
- There is no detector between Target Pb wall and concrete
- No targets upstream of the target

# Spherical detector: allPZ DS half

energy distribution second half allPZ em

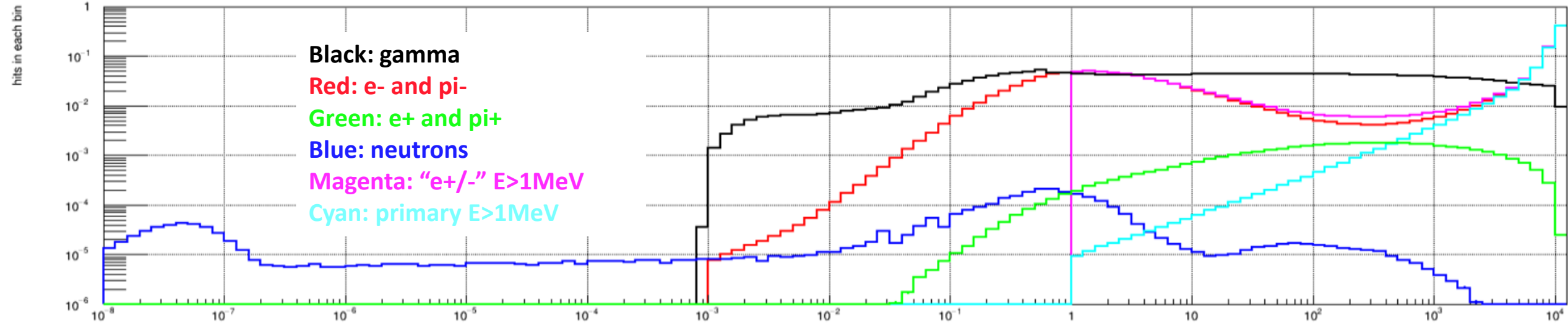

energy distribution second half allPZ em

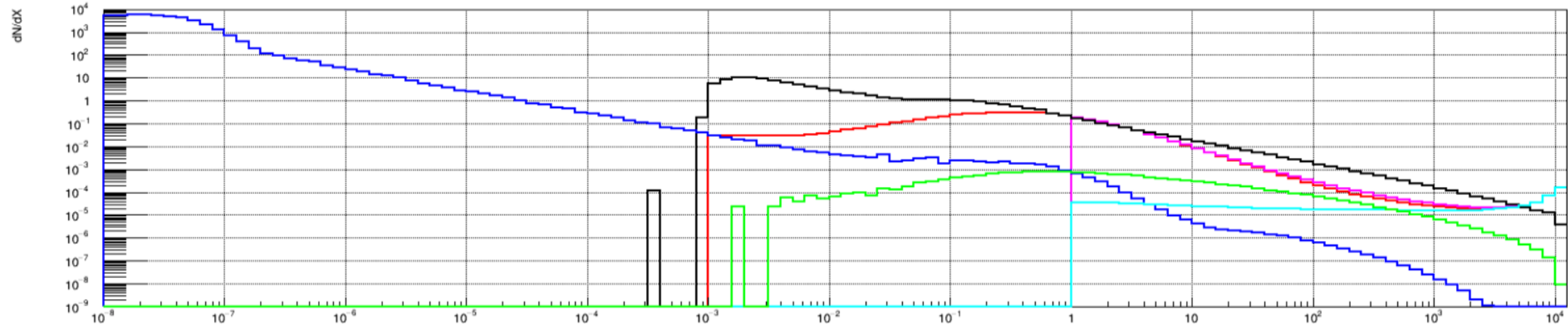

# Spherical detector: allPZ US half

